



BEAVERCRAFT

CATALOG

Content

About Us.....	4
Wood Carving Knives.....	6
Blades.....	16
Spoon Carving Knives.....	24
Drawknives.....	30
Gouges & Chisels.....	34
Tool Sets.....	44
Premium Tool Sets.....	60
DIY Hobby Kits.....	70
Axes.....	88
Wood.....	94
Sharpening.....	106
Accessories.....	112
Contact.....	126

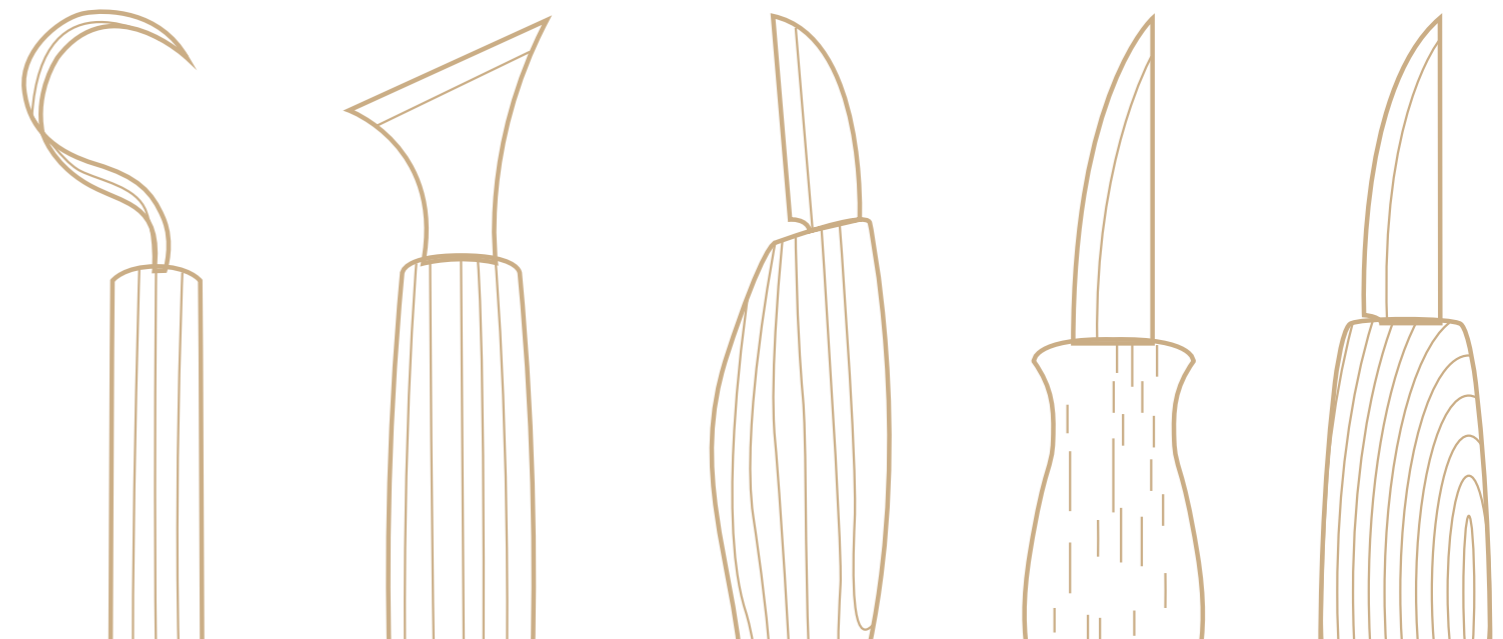

About Us



60
talented team members



10 000
axes produced



2014
the company is founded



250 000
hobbyists in our online community



1000
cubic meters of wood processed annually



700 000
carving tools crafted



50
export to countries around the world



1 million
customers around the globe



Wood Carving Knives

A versatile range of wood carving knives designed for different carving techniques and suitable for all skill levels. Featuring High-Carbon Steel blades paired with ergonomic natural wooden handles.

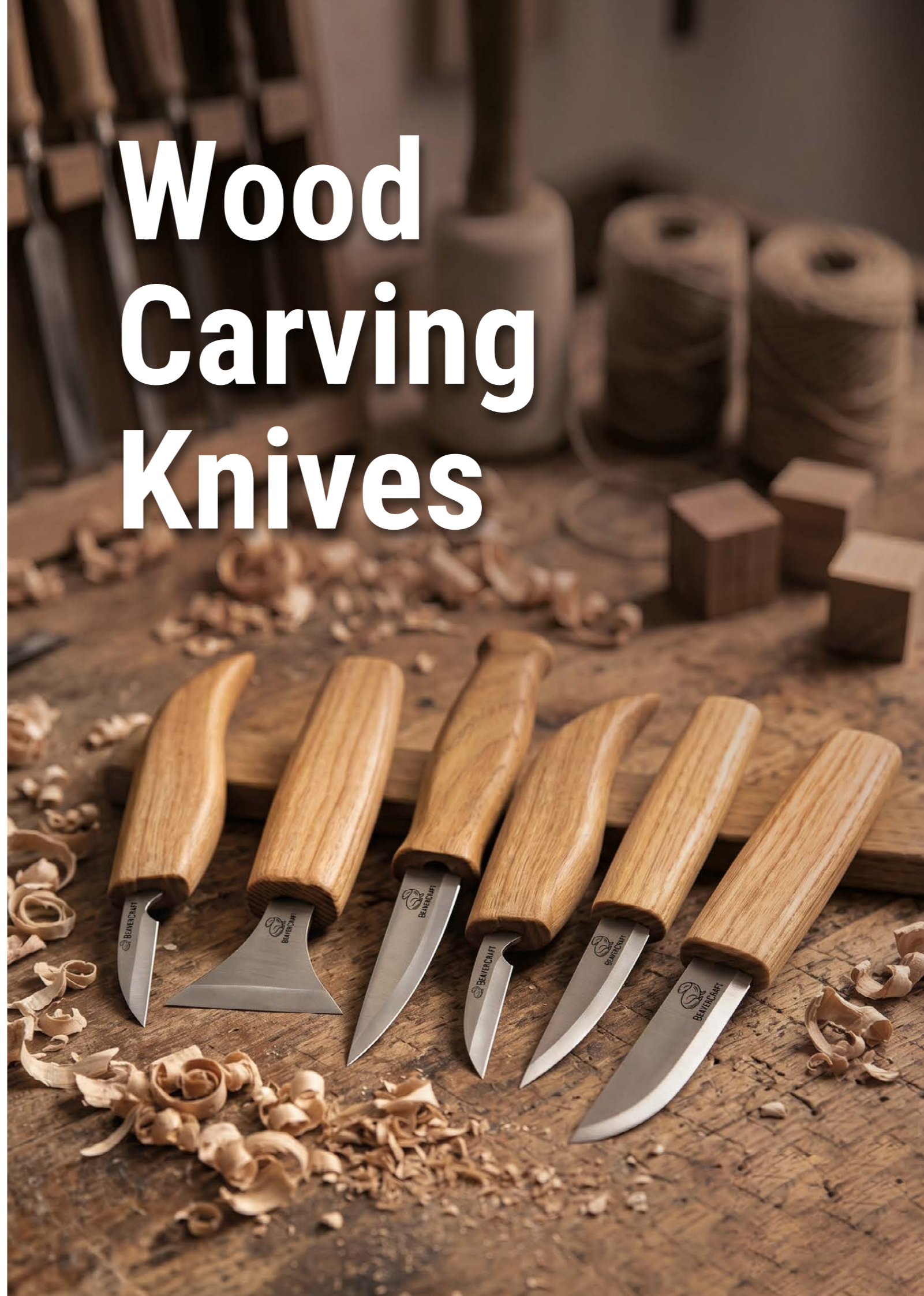

C1 – Sloyd Whittling Knife

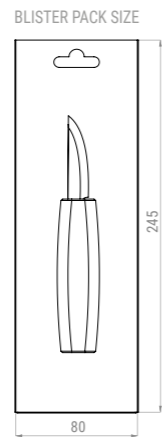

Total length, mm/"	165/6.5
Handle length, mm/"	105/4.1
Handle material	Ash wood
Blade length/Cutting edge length, mm/"	60/2.4
Blade width, mm/"	14/0.6
Blade thickness, mm/"	2/0.08
Blade material	High-Carbon Steel
Hardness	57–59 HRC
Grind type	Scandi
Bevel angle	20°
Weight (net), g/(oz)	42/1.5
Weight (gross), g/(oz)	67/2.4
Pcs per carton	100

C1M – Sloyd Whittling Knife

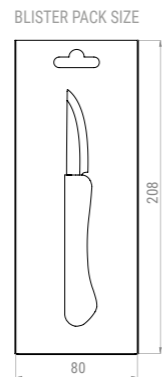

Total length, mm/"	165/6.5
Handle length, mm/"	105/4.1
Handle material	Ash wood
Blade length/Cutting edge length, mm/"	60/2.4
Blade width, mm/"	14/0.6
Blade thickness, mm/"	2/0.08
Blade material	High-Carbon Steel
Hardness	57–59 HRC
Grind type	Scandi
Bevel angle	20°
Weight (net), g/(oz)	33/1.2
Weight (gross), g/(oz)	58/2
Pcs per carton	100

C1 kid – Whittling Knife for Kids and Beginners

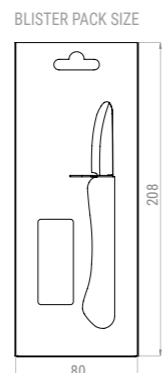

Total length, mm/"	155/6.1
Handle length, mm/"	105/4.1
Handle material	Ash wood
Blade length/Cutting edge length, mm/"	50/2
Blade width, mm/"	14/0.6
Blade thickness, mm/"	2/0.08
Blade material	High-Carbon Steel
Hardness	57–59 HRC
Grind type	Scandi
Bevel angle	20°
Weight (net), g/(oz)	43/1.5
Weight (gross), g/(oz)	67/2.4
Pcs per carton	100

C2 – Wood Carving Bench Knife

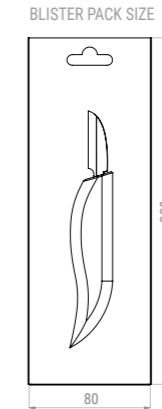

Total length, mm/"	165/6.5
Handle length, mm/"	125/4.9
Handle material	Ash wood
Blade length/Cutting edge length, mm/"	40/1.6
Blade width, mm/"	13/0.5
Blade thickness, mm/"	2/0.08
Blade material	High-Carbon Steel
Hardness	57–59 HRC
Grind type	Scandi
Bevel angle	20°
Weight (net), g/(oz)	36/1.3
Weight (gross), g/(oz)	59/2
Pcs per carton	100

C3 – Whittling Knife

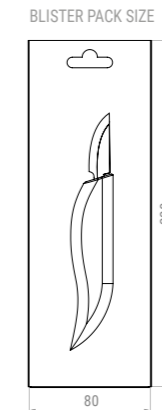

Total length, mm/"	165/6.5
Handle length, mm/"	125/4.9
Handle material	Ash wood
Blade length/Cutting edge length, mm/"	40/1.6
Blade width, mm/"	14/0.6
Blade thickness, mm/"	2/0.08
Blade material	High-Carbon Steel
Hardness	57–59 HRC
Grind type	Scandi
Bevel angle	20°
Weight (net), g/(oz)	36/1.3
Weight (gross), g/(oz)	59/2
Pcs per carton	100

C4 – Sloyd Whittling Knife

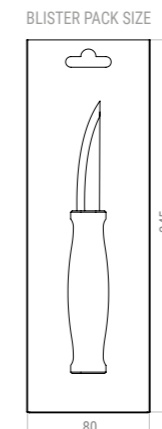

Total length, mm/"	200/7.9
Handle length, mm/"	120/4.7
Handle material	Oak
Blade length/Cutting edge length, mm/"	80/3.2
Blade width, mm/"	16/0.6
Blade thickness, mm/"	2/0.08
Blade material	High-Carbon Steel
Hardness	57–59 HRC
Grind type	Scandi
Bevel angle	20°
Weight (net), g/(oz)	42/1.5
Weight (gross), g/(oz)	70/2.5
Pcs per carton	100

C4S – Sloyd Whittling Knife with Leather Sheath



Total length, mm/"	200/7.9
Handle length, mm/"	120/4.7
Handle material	Oak
Blade length/Cutting edge length, mm/"	80/3.2
Blade width, mm/"	16/0.6
Blade thickness, mm/"	2/0.08
Blade material	High-Carbon Steel
Hardness	57–59 HRC
Grind type	Scandi
Bevel angle	20°
Weight (net), g/(oz)	87/3.1
Weight (gross), g/(oz)	126/4.4
Pcs per carton	50

C4M – Sloyd Whittling Knife



Total length, mm/"	185/7.3
Handle length, mm/"	105/4.1
Handle material	Ash wood
Blade length/Cutting edge length, mm/"	80/3.2
Blade width, mm/"	16/0.6
Blade thickness, mm/"	2/0.08
Blade material	High-Carbon Steel
Hardness	57–59 HRC
Grind type	Scandi
Bevel angle	20°
Weight (net), g/(oz)	45/1.6
Weight (gross), g/(oz)	72/2.5
Pcs per carton	100

C5 – Wood Carving Bench Knife



Total length, mm/"	155/6.1
Handle length, mm/"	105/4.1
Handle material	Ash wood
Blade length/Cutting edge length, mm/"	50/2
Blade width, mm/"	14/0.6
Blade thickness, mm/"	2/0.08
Blade material	High-Carbon Steel
Hardness	57–59 HRC
Grind type	Scandi
Bevel angle	20°
Weight (net), g/(oz)	42/1.5
Weight (gross), g/(oz)	67/2.4
Pcs per carton	100

C6 – Chip Carving Knife



Total length, mm/"	150/5.9
Handle length, mm/"	125/4.9
Handle material	Ash wood
Blade length/Cutting edge length, mm/"	25/1
Blade width, mm/"	10/0.4
Blade thickness, mm/"	2/0.08
Blade material	High-Carbon Steel
Hardness	57–59 HRC
Grind type	Scandi
Bevel angle	20°
Weight (net), g/(oz)	31/1.1
Weight (gross), g/(oz)	54/1.9
Pcs per carton	100

C7 – Detail Carving Knife



Total length, mm/"	170/6.7
Handle length, mm/"	105/4.1
Handle material	Ash wood
Blade length/Cutting edge length, mm/"	45/1.8
Blade width, mm/"	10/0.4
Blade thickness, mm/"	2/0.08
Blade material	High-Carbon Steel
Hardness	57–59 HRC
Grind type	Scandi
Bevel angle	20°
Weight (net), g/(oz)	39/1.4
Weight (gross), g/(oz)	64/2.3
Pcs per carton	100

C8 – Detail Carving Knife



Total length, mm/"	165/6.5
Handle length, mm/"	125/4.9
Handle material	Ash wood
Blade length/Cutting edge length, mm/"	35/1.6
Blade width, mm/"	8/0.3
Blade thickness, mm/"	2/0.08
Blade material	High-Carbon Steel
Hardness	57–59 HRC
Grind type	Scandi
Bevel angle	20°
Weight (net), g/(oz)	33/1.2
Weight (gross), g/(oz)	58/2
Pcs per carton	100

C9 – Chip Carving Knife

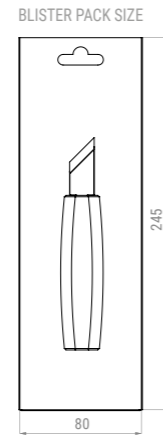

Total length, mm/"	145/5.7
Handle length, mm/"	105/4.1
Handle material	Ash wood
Blade length/Cutting edge length, mm/"	25/1
Blade width, mm/"	17/0.6
Blade thickness, mm/"	2/0.08
Blade material	High-Carbon Steel
Hardness	57–59 HRC
Grind type	Scandi
Bevel angle	20°
Weight (net), g/(oz)	37/1.3
Weight (gross), g/(oz)	62/2.2
Pcs per carton	100

C10 – Chip Carving Knife

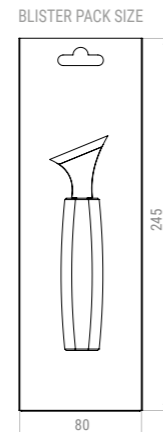

Total length, mm/"	150/5.9
Handle length, mm/"	105/4.1
Handle material	Ash wood
Blade length/Cutting edge length, mm/"	40/1.6
Blade width, mm/"	40/1.6
Blade thickness, mm/"	2/0.08
Blade material	High-Carbon Steel
Hardness	57–59 HRC
Grind type	Scandi
Bevel angle	20°
Weight (net), g/(oz)	44/1.6
Weight (gross), g/(oz)	70/2.5
Pcs per carton	100

C10s – Chip Carving Knife

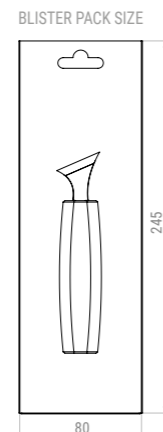

Total length, mm/"	140/5.5
Handle length, mm/"	105/4.1
Handle material	Ash wood
Blade length/Cutting edge length, mm/"	30/1.2
Blade width, mm/"	27/1.1
Blade thickness, mm/"	2/0.08
Blade material	High-Carbon Steel
Hardness	57–59 HRC
Grind type	Scandi
Bevel angle	20°
Weight (net), g/(oz)	41/1.5
Weight (gross), g/(oz)	67/2.4
Pcs per carton	100

C11 – Chip Carving Knife

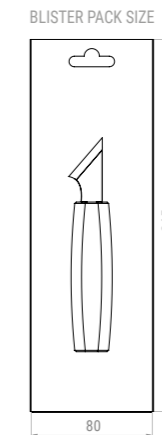

Total length, mm/"	150/5.9
Handle length, mm/"	105/4.1
Handle material	Ash wood
Blade length/Cutting edge length, mm/"	35/1.6
Blade width, mm/"	25/1
Blade thickness, mm/"	2/0.08
Blade material	High-Carbon Steel
Hardness	57–59 HRC
Grind type	Scandi
Bevel angle	20°
Weight (net), g/(oz)	44/1.6
Weight (gross), g/(oz)	70/2.5
Pcs per carton	100

C11s – Chip Carving Knife

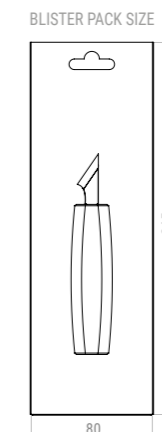

Total length, mm/"	140/5.5
Handle length, mm/"	105/4.1
Handle material	Ash wood
Blade length/Cutting edge length, mm/"	25/1
Blade width, mm/"	15/0.6
Blade thickness, mm/"	2/0.08
Blade material	High-Carbon Steel
Hardness	57–59 HRC
Grind type	Scandi
Bevel angle	20°
Weight (net), g/(oz)	41/1.5
Weight (gross), g/(oz)	67/2.4
Pcs per carton	100

C12 – Chip Carving Knife

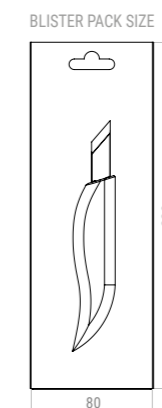

Total length, mm/"	160/6.3
Handle length, mm/"	125/4.9
Handle material	Ash wood
Blade length/Cutting edge length, mm/"	20/0.8
Blade width, mm/"	18/0.7
Blade thickness, mm/"	2/0.08
Blade material	High-Carbon Steel
Hardness	57–59 HRC
Grind type	Scandi
Bevel angle	20°
Weight (net), g/(oz)	37/1.3
Weight (gross), g/(oz)	62/2.2
Pcs per carton	100

C13 – Whittling Knife

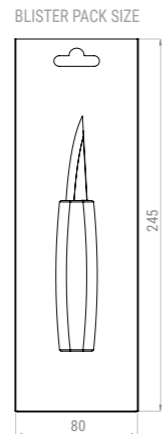

Total length, mm/"	160/6.3
Handle length, mm/"	105/4.1
Handle material	Ash wood
Blade length/Cutting edge length, mm/"	55/2.2
Blade width, mm/"	14/0.6
Blade thickness, mm/"	2/0.08
Blade material	High-Carbon Steel
Hardness	57–59 HRC
Grind type	Scandi
Bevel angle	20°
Weight (net), g/(oz)	42/1.5
Weight (gross), g/(oz)	69/2.4
Pcs per carton	100

C14 – Wood Carving Bench Knife

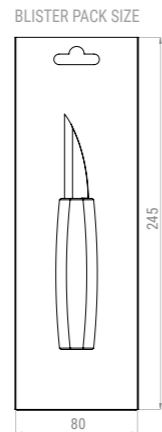

Total length, mm/"	165/6.5
Handle length, mm/"	105/4.1
Handle material	Ash wood
Blade length/Cutting edge length, mm/"	60/2.4
Blade width, mm/"	16/0.6
Blade thickness, mm/"	2/0.08
Blade material	High-Carbon Steel
Hardness	57–59 HRC
Grind type	Scandi
Bevel angle	20°
Weight (net), g/(oz)	44/1.6
Weight (gross), g/(oz)	70/2.5
Pcs per carton	100

C15 – Detail Carving Knife

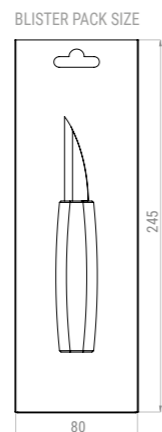

Total length, mm/"	160/6.3
Handle length, mm/"	125/4.9
Handle material	Ash wood
Blade length/Cutting edge length, mm/"	35/1.4
Blade width, mm/"	8/0.3
Blade thickness, mm/"	2/0.08
Blade material	High-Carbon Steel
Hardness	57–59 HRC
Grind type	Scandi
Bevel angle	20°
Weight (net), g/(oz)	33/1.2
Weight (gross), g/(oz)	55/1.9
Pcs per carton	100

C16 – Roughing Knife

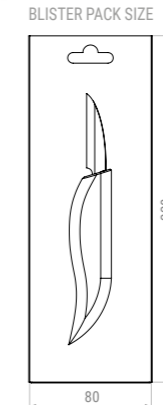

Total length, mm/"	175/6.9
Handle length, mm/"	125/4.9
Handle material	Ash wood
Blade length/Cutting edge length, mm/"	50/2
Blade width, mm/"	13/0.5
Blade thickness, mm/"	2/0.08
Blade material	High-Carbon Steel
Hardness	57–59 HRC
Grind type	Scandi
Bevel angle	20°
Weight (net), g/(oz)	37/1.3
Weight (gross), g/(oz)	62/2.2
Pcs per carton	100

C17p – Universal Wood Carving Knife (Palm-Handled)

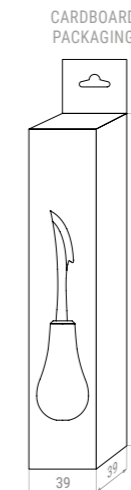

Total length, mm/"	160/6.3
Handle length, mm/"	75/3
Handle material	Ash wood
Blade length/Cutting edge length, mm/"	40/1.6
Blade width, mm/"	12/0.5
Blade thickness, mm/"	2/0.08
Blade material	High-Carbon Steel
Hardness	57–59 HRC
Grind type	Scandi
Bevel angle	20°
Weight (net), g/(oz)	52/1.8
Weight (gross), g/(oz)	65/2.3
Pcs per carton	50

C18 – Curved Carving Knife

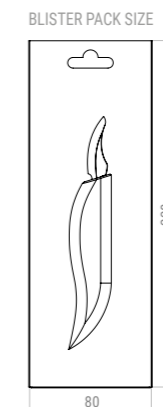

Total length, mm/"	165/6.5
Handle length, mm/"	125/4.9
Handle material	Ash wood
Blade length/Cutting edge length, mm/"	40/1.6
Blade width, mm/"	13/0.5
Blade thickness, mm/"	1/0.04
Blade material	High-Carbon Steel
Hardness	57–59 HRC
Grind type	Scandi
Bevel angle	20°
Weight (net), g/(oz)	35/1.3
Weight (gross), g/(oz)	60/2.1
Pcs per carton	100

Blades

Replacement blades for wood carving knives made from High-Carbon Steel. Available for whittling, spoon carving, chip carving, detail carving, and other knife types.

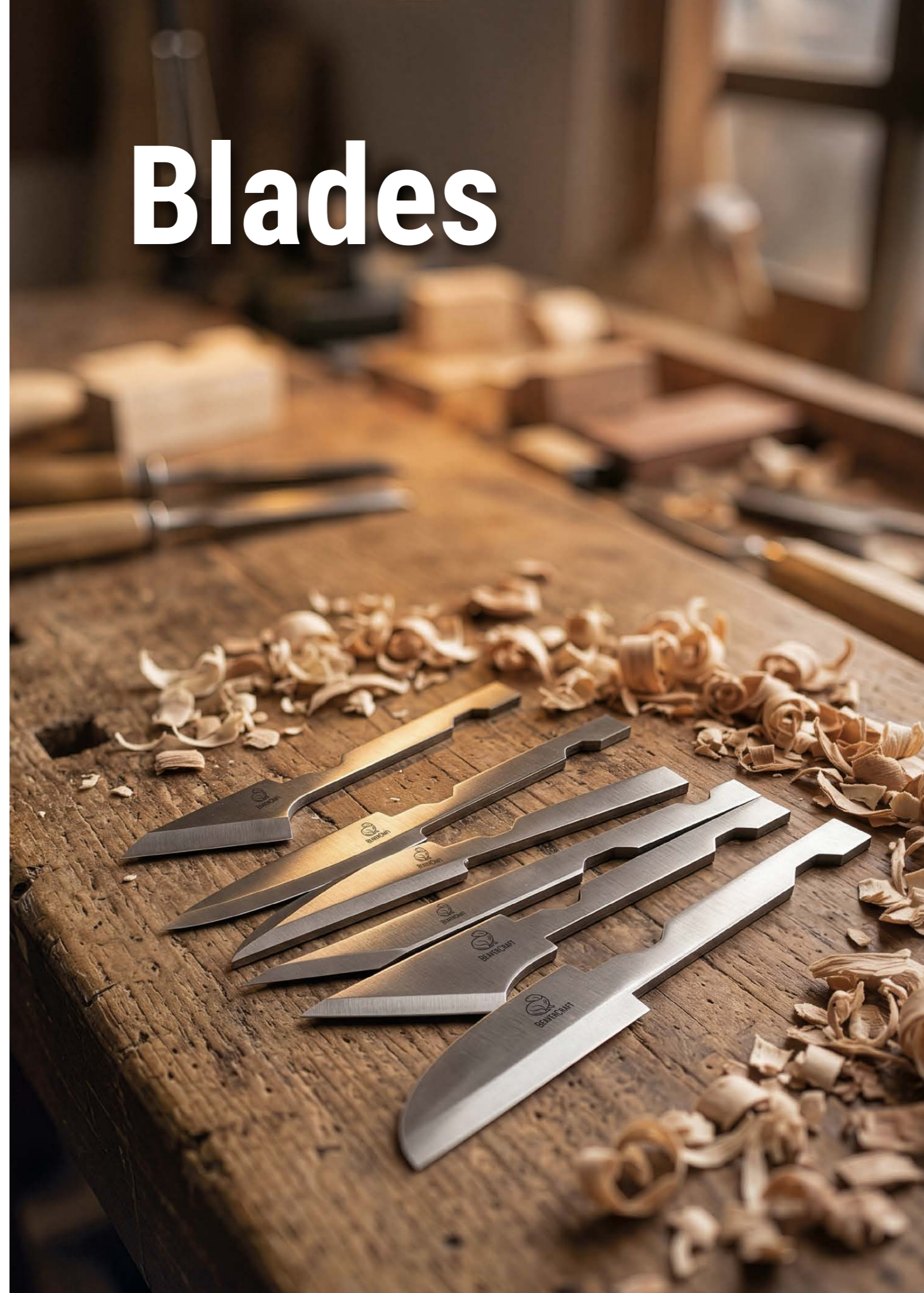

BC1 – Replacement Blade for Sloyd Whittling Knife



Total length, mm/"	120/4.7
Blade length/Cutting edge length, mm/"	60/2.4
Blade width, mm/"	14/0.6
Blade thickness, mm/"	2/0.08
Tang Length, mm/"	60/2.4
Blade material	High-Carbon Steel
Hardness	57–59 HRC
Grind type	Scandi
Bevel angle	20°
Weight (net), g/(oz)	84/3
Weight (gross), g/(oz)	118/4.2
Pcs per carton	6

BC4 – Replacement Blade for Sloyd Whittling Knife



Total length, mm/"	140/5.5
Blade length/Cutting edge length, mm/"	80/3.2
Blade width, mm/"	16/0.6
Blade thickness, mm/"	2/0.08
Tang Length, mm/"	60/2.4
Blade material	High-Carbon Steel
Hardness	57–59 HRC
Grind type	Scandi
Bevel angle	20°
Weight (net), g/(oz)	102/3.6
Weight (gross), g/(oz)	136/4.8
Pcs per carton	6

BC2 – Replacement Blade for Bench Carving Knife



Total length, mm/"	100/3.9
Blade length/Cutting edge length, mm/"	40/1.6
Blade width, mm/"	13/0.5
Blade thickness, mm/"	2/0.08
Tang Length, mm/"	60/2.4
Blade material	High-Carbon Steel
Hardness	57–59 HRC
Grind type	Scandi
Bevel angle	20°
Weight (net), g/(oz)	72/2.6
Weight (gross), g/(oz)	106/3.7
Pcs per carton	6

BC5 – Replacement Blade for Bench Carving Knife



Total length, mm/"	110/4.3
Blade length/Cutting edge length, mm/"	50/2
Blade width, mm/"	14/0.6
Blade thickness, mm/"	2/0.08
Tang Length, mm/"	60/2.4
Blade material	High-Carbon Steel
Hardness	57–59 HRC
Grind type	Scandi
Bevel angle	20°
Weight (net), g/(oz)	90/3.2
Weight (gross), g/(oz)	124/4.4
Pcs per carton	6

BC3 – Replacement Blade for Whittling Knife



Total length, mm/"	100/3.9
Blade length/Cutting edge length, mm/"	40/1.6
Blade width, mm/"	14/0.6
Blade thickness, mm/"	2/0.08
Tang Length, mm/"	60/2.4
Blade material	High-Carbon Steel
Hardness	57–59 HRC
Grind type	Scandi
Bevel angle	20°
Weight (net), g/(oz)	78/2.8
Weight (gross), g/(oz)	112/4
Pcs per carton	6

BC6 – Replacement Blade for Chip Carving Knife

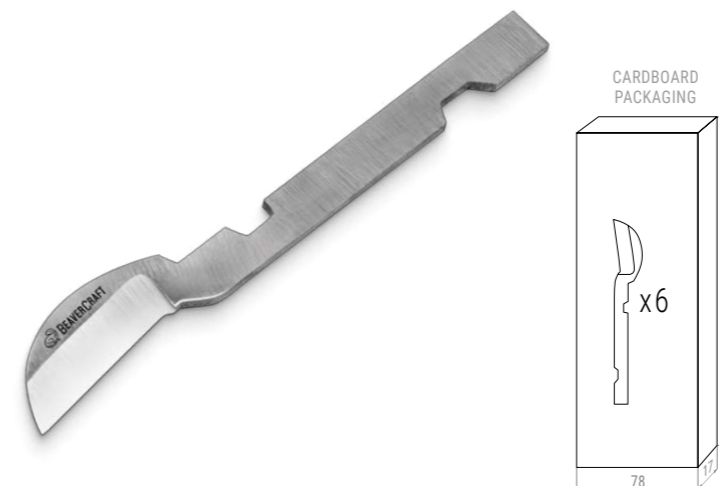

Total length, mm/"	90/3.5
Blade length/Cutting edge length, mm/"	25/1
Blade width, mm/"	10/0.4
Blade thickness, mm/"	2/0.08
Tang Length, mm/"	60/2.4
Blade material	High-Carbon Steel
Hardness	57–59 HRC
Grind type	Scandi
Bevel angle	20°
Weight (net), g/(oz)	54/1.9
Weight (gross), g/(oz)	94/3.3
Pcs per carton	6

BC7 – Replacement Blade for Detail Carving Knife

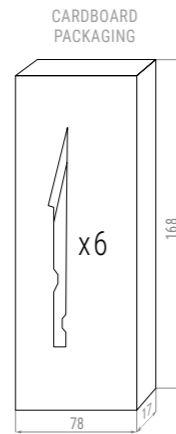

Total length, mm/"	105/4.1
Blade length/Cutting edge length, mm/"	45/1.8
Blade width, mm/"	10/0.4
Blade thickness, mm/"	2/0.08
Tang Length, mm/"	60/2.4
Blade material	High-Carbon Steel
Hardness	57–59 HRC
Grind type	Scandi
Bevel angle	20°
Weight (net), g/(oz)	72/2.6
Weight (gross), g/(oz)	106/3.7
Pcs per carton	6

BC8 – Replacement Blade for Detail Carving Knife

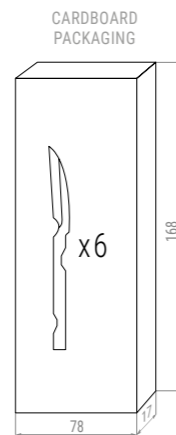

Total length, mm/"	105/4.1
Blade length/Cutting edge length, mm/"	35/1.6
Blade width, mm/"	8/0.3
Blade thickness, mm/"	2/0.08
Tang Length, mm/"	60/2.4
Blade material	High-Carbon Steel
Hardness	57–59 HRC
Grind type	Scandi
Bevel angle	20°
Weight (net), g/(oz)	68/2.4
Weight (gross), g/(oz)	100/3.5
Pcs per carton	6

BC9 – Replacement Blade for Chip Carving Knife

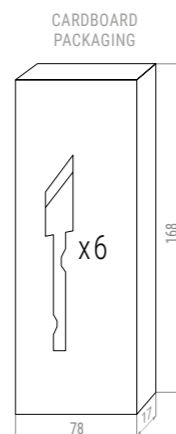

Total length, mm/"	95/3.7
Blade length/Cutting edge length, mm/"	25/1
Blade width, mm/"	17/0.6
Blade thickness, mm/"	2/0.08
Tang Length, mm/"	60/2.4
Blade material	High-Carbon Steel
Hardness	57–59 HRC
Grind type	Scandi
Bevel angle	20°
Weight (net), g/(oz)	84/3
Weight (gross), g/(oz)	118/4.2
Pcs per carton	6

BC10/BC10s – Replacement Blade for Chip Carving Knife

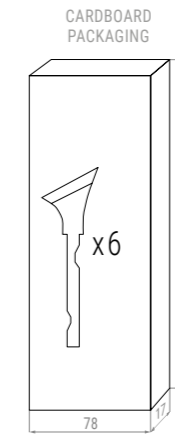

Total length, mm/"	C10-105/4.1; C10s-95/3.7
Cutting edge length, mm/"	C10-40/1.6; C10s-30/1.2
Blade width, mm/"	C10-40/1.6; C10s-27/1.1
Blade thickness, mm/"	2/0.08
Tang Length, mm/"	60/2.4
Blade material	High-Carbon Steel
Hardness	57–59 HRC
Grind type	Scandi
Bevel angle	20°
Weight (net), g/(oz)	C10-96/3.4; C10s-68/2.4
Weight (gross), g/(oz)	C10-130/4.6; C10s-100/3.5
Pcs per carton	6

BC11/BC11s – Replacement Blade for Chip Carving Knife

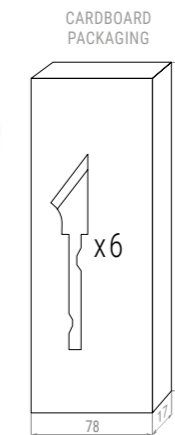

Total length, mm/"	C11-105/4.1; C11s-95/3.7
Cutting edge length, mm/"	C11-35/1.6; C11s-25/1
Blade width, mm/"	C11-25/1; C11s-15/0.6
Blade thickness, mm/"	2/0.08
Tang Length, mm/"	60/2.4
Blade material	High-Carbon Steel
Hardness	57–59 HRC
Grind type	Scandi
Bevel angle	20°
Weight (net), g/(oz)	C11-90/3.2; C11s-68/2.4
Weight (gross), g/(oz)	C11-124/4.4; C11s-100/3.5
Pcs per carton	6

BC12 – Replacement Blade for Chip Carving Knife

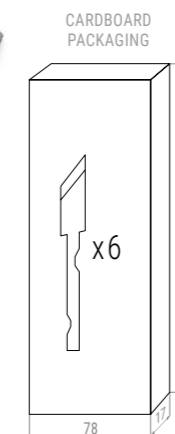

Total length, mm/"	95/3.7
Blade length/Cutting edge length, mm/"	20/0.8
Blade width, mm/"	18/0.7
Blade thickness, mm/"	2/0.08
Tang Length, mm/"	60/2.4
Blade material	High-Carbon Steel
Hardness	57–59 HRC
Grind type	Scandi
Bevel angle	20°
Weight (net), g/(oz)	78/2.8
Weight (gross), g/(oz)	112/4.0
Pcs per carton	6

BC13 – Replacement Blade for Whittling Knife



Total length, mm/"	115/4
Blade length/Cutting edge length, mm/"	55/2.2
Blade width, mm/"	14/0.6
Blade thickness, mm/"	2/0.08
Tang Length, mm/"	60/2.4
Blade material	High-Carbon Steel
Hardness	57–59 HRC
Grind type	Scandi
Bevel angle	20°
Weight (net), g/(oz)	84/3
Weight (gross), g/(oz)	118/4.2
Pcs per carton	6

BC16 – Replacement Blade for Roughing Knife



Total length, mm/"	110/4.3
Blade length/Cutting edge length, mm/"	50/2
Blade width, mm/"	13/0.5
Blade thickness, mm/"	2/0.08
Tang Length, mm/"	60/2.4
Blade material	High-Carbon Steel
Hardness	57–59 HRC
Grind type	Scandi
Bevel angle	20°
Weight (net), g/(oz)	78/2.8
Weight (gross), g/(oz)	112/4
Pcs per carton	6

BC14 – Replacement Blade for Bench Carving Knife



Total length, mm/"	120/4.7
Blade length/Cutting edge length, mm/"	60/2.4
Blade width, mm/"	16/0.6
Blade thickness, mm/"	2/0.08
Tang Length, mm/"	60/2.4
Blade material	High-Carbon Steel
Hardness	57–59 HRC
Grind type	Scandi
Bevel angle	20°
Weight (net), g/(oz)	84/3
Weight (gross), g/(oz)	118/4.2
Pcs per carton	6

BSK1 – Replacement Blade for Spoon Carving Knife



Total length, mm/"	110/4.3
Blade length/Cutting edge length, mm/"	50/2
Blade width, mm/"	16/0.6
Blade thickness, mm/"	2/0.08
Tang Length, mm/"	60/2.4
Curve diameter	25/1
Hand orientation	Right-handed
Blade material	High-Carbon Steel
Hardness	57–59 HRC
Grind type	Chisel
Bevel angle	20°
Weight (net), g/(oz)	114/4
Weight (gross), g/(oz)	148/5.2
Pcs per carton	6

BC15 – Replacement Blade for Detail Carving Knife



Total length, mm/"	95/3.7
Blade length/Cutting edge length, mm/"	35/1.4
Blade width, mm/"	8/0.3
Blade thickness, mm/"	2/0.08
Tang Length, mm/"	60/2.4
Blade material	High-Carbon Steel
Hardness	57–59 HRC
Grind type	Scandi
Bevel angle	20°
Weight (net), g/(oz)	54/1.9
Weight (gross), g/(oz)	88/3.1
Pcs per carton	6

BSK2 – Replacement Blade for Spoon Carving Knife



Total length, mm/"	130/5.1
Blade length/Cutting edge length, mm/"	70/2.8
Blade width, mm/"	16/0.6
Blade thickness, mm/"	2/0.08
Tang Length, mm/"	60/2.4
Curve diameter	30/1.2
Hand orientation	Right-handed
Blade material	High-Carbon Steel
Hardness	57–59 HRC
Grind type	Chisel
Bevel angle	20°
Weight (net), g/(oz)	168/5.9
Weight (gross), g/(oz)	202/7.1
Pcs per carton	6

Specialized hook knives designed for carving spoons and other concave shapes. Made from High-Carbon Steel with comfortable wooden handles in different blade profiles and cutting edge sizes.

Spoon Carving Knives



SK1/SK1S – Spoon Carving Knife with Leather Sheath



Total length, mm/"	160/6.3
Handle length, mm/"	105/4.1
Handle material	Ash wood
Cutting edge length, mm/"	55/2.2
Blade width, mm/"	17/0.7
Blade thickness, mm/"	2/0.08
Curve diameter	25/1
Blade material	High-Carbon Steel
Hardness	57–59 HRC
Grind type	Chisel
Bevel angle	20°
Weight (net), g/(oz)	SK1-50/1.8; SK1S-67/2.4
Weight (gross), g/(oz)	SK1-80/2.8; SK1S-80/2.8
Pcs per carton	50

* Available in right- and left-handed versions

SK2/SK2S – Spoon Carving Knife with Leather Sheath



Total length, mm/"	170/6.7
Handle length, mm/"	105/4.1
Handle material	Ash wood
Cutting edge length, mm/"	60/2.4
Blade width, mm/"	16/0.6
Blade thickness, mm/"	2/0.08
Curve diameter	30/1.2
Blade material	High-Carbon Steel
Hardness	57–59 HRC
Grind type	Chisel
Bevel angle	20°
Weight (net), g/(oz)	SK2-63/2.2; SK2S-78/2.8
Weight (gross), g/(oz)	SK2-93/3.3; SK2S-92/3.3
Pcs per carton	50

* Available in right- and left-handed versions

SK1 OAK/SK1S Oak – Spoon Carving Knife with Oak Handle and Leather Sheath



Total length, mm/"	185/7.3
Handle length, mm/"	135/5.3
Handle material	Oak
Cutting edge length, mm/"	50/2.2
Blade width, mm/"	17/0.7
Blade thickness, mm/"	2/0.08
Curve diameter	25/1
Blade material	High-Carbon Steel
Hardness	57–59 HRC
Grind type	Chisel
Bevel angle	20°
Weight (net), g/(oz)	SK1-52/1.8; SK1S-67/2.4
Weight (gross), g/(oz)	SK1-78/2.8; SK1S-80/2.8
Pcs per carton	50

* Available in right- and left-handed versions

SK2 OAK/SK2S Oak – Spoon Carving Knife with Oak Handle and Leather Sheath



Total length, mm/"	200/7.9
Handle length, mm/"	135/5.3
Handle material	Oak
Cutting edge length, mm/"	60/2.4
Blade width, mm/"	16/0.6
Blade thickness, mm/"	2/0.08
Curve diameter	30/1.2
Blade material	High-Carbon Steel
Hardness	57–59 HRC
Grind type	Chisel
Bevel angle	20°
Weight (net), g/(oz)	SK2-59/2.1; SK2S-75/2.7
Weight (gross), g/(oz)	SK2-87/3.1; SK2S-89/3.2
Pcs per carton	50

* Available in right- and left-handed versions

SK2 Long/SK2S Long – Long Handle Spoon Carving Knife with Leather Sheath

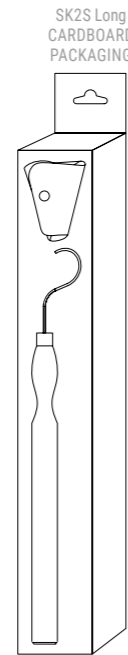

Total length, mm/"	365/14.4
Handle length, mm/"	300/11.8
Handle material	Ash wood
Cutting edge length, mm/"	60/2.4
Blade width, mm/"	16/0.6
Blade thickness, mm/"	2/0.08
Curve diameter	30/1.2
Blade material	High-Carbon Steel
Hardness	57-59 HRC
Grind type	Chisel
Bevel angle	20°
Weight (net), g/(oz)	SK2-144/5.1; SK2S-160/5.7
Weight (gross), g/(oz)	SK2-216/7.6; SK2S-231/8.2
Pcs per carton	30

SK4S – Open Curve Spoon Carving Knife with Oak Handle and Leather Sheath

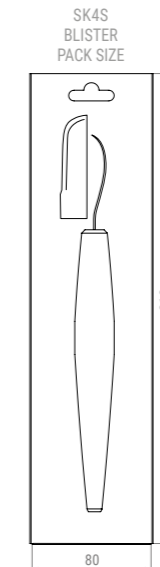

Total length, mm/"	265/10.4
Handle length, mm/"	200/7.9
Handle material	Oak
Cutting edge length, mm/"	60/2.4
Blade width, mm/"	12/0.5
Blade thickness, mm/"	2/0.08
Blade material	High-Carbon Steel
Hardness	57-59 HRC
Grind type	Chisel, False edge
Bevel angle	20°
Weight (net), g/(oz)	73/2.6
Weight (gross), g/(oz)	108/3.8
Pcs per carton	50

SK3 Long – Long Handle Open Curve Spoon Carving Knife

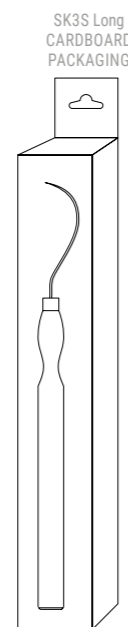

Total length, mm/"	410/16.1
Handle length, mm/"	300/11.8
Handle material	Ash wood
Cutting edge length, mm/"	90/3.5
Blade width, mm/"	17/0.7
Blade thickness, mm/"	2/0.08
Blade material	High-Carbon Steel
Hardness	57-59 HRC
Grind type	Symmetrical Chisel
Bevel angle	20°
Weight (net), g/(oz)	165/5.8
Weight (gross), g/(oz)	242/8.6
Pcs per carton	30

SK5/SK5S – Spoon Carving Knife with Oak Handle and Leather Sheath

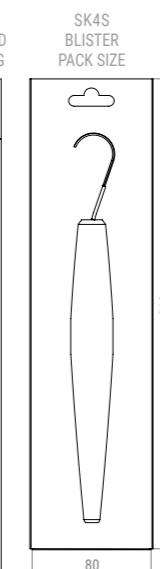
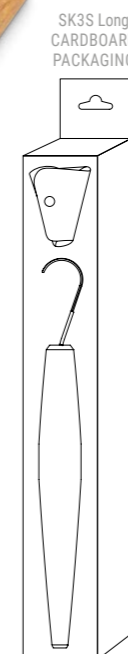

Total length, mm/"	255/10
Handle length, mm/"	200/7.9
Handle material	Oak
Cutting edge length, mm/"	60/2.4
Blade width, mm/"	14/0.6
Blade thickness, mm/"	2/0.08
Curve diameter	25/1
Blade material	High-Carbon Steel
Hardness	57-59 HRC
Grind type	Symmetrical Double-edge
Bevel angle	18°, 11°
Weight (net), g/(oz)	SK5-67/2.4; SK5S-83/2.9
Weight (gross), g/(oz)	SK5-102/3.6; SK5S-100/3.5
Pcs per carton	50

* Available in right- and left-handed versions

Drawknives

Traditional woodworking drawknives used for debarking logs, rough shaping, and preparing wood blanks for carving or joinery work. Made with High-Carbon Steel blades and ergonomic handles for two-handed operation.



DK1S – Drawknife with Oak Handles and Leather Sheath



Total length, mm/"	360/14.1
Handle length, mm/"	120/4.7
Handle material	Oak
Blade length/Cutting edge length, mm/"	120/4.7
Cutting edge length, mm/"	110/4.3
Blade width, mm/"	20/0.8
Blade thickness, mm/"	3/0.12
Blade material	High-Carbon Steel
Hardness	57-59 HRC
Grind type	Scandi
Bevel angle	30°
Weight (net), g/(oz)	140/5
Weight (gross), g/(oz)	150/5.3
Pcs per carton	50

DK2S – Drawknife with Leather Sheath



Total length, mm/"	335/13.2
Handle length, mm/"	107/4.2
Handle material	Ash wood
Blade length/Cutting edge length, mm/"	120/4.7
Cutting edge length, mm/"	110/4.3
Blade width, mm/"	20/0.8
Blade thickness, mm/"	3/0.12
Blade material	High-Carbon Steel
Hardness	57-59 HRC
Grind type	Scandi
Bevel angle	30°
Weight (net), g/(oz)	140/4.9
Weight (gross), g/(oz)	150/5.3
Pcs per carton	50

DK3S – Drawknife with Walnut Handles and Leather Sheath



Total length, mm/"	280/11
Handle length, mm/"	100/3.9
Handle material	Walnut
Blade length/Cutting edge length, mm/"	190/7.4
Cutting edge length, mm/"	110/4.3
Blade width, mm/"	30/1.2
Blade thickness, mm/"	5/0.19
Blade material	High-Carbon Steel
Hardness	57-59 HRC
Grind type	Scandi
Bevel angle	30°
Weight (net), g/(oz)	400/14.1
Weight (gross), g/(oz)	425/15.2
Pcs per carton	50

DK4S – Hand-Forged Drawknife with Walnut Handles and Leather Sheath



Total length, mm/"	390/15.3
Handle length, mm/"	135/5.3
Handle material	Walnut
Blade length/Cutting edge length, mm/"	360/14.1
Cutting edge length, mm/"	225/10
Blade width, mm/"	35/1.4
Blade thickness, mm/"	4.5/0.18
Blade material	High-Carbon Steel
Hardness	56-58 HRC
Grind type	Scandi
Bevel angle	30°
Weight (net), g/(oz)	600/21
Pcs per carton	6

DK5S – Small Hand-Forged Drawknife with Leather Sheath



Total length, mm/"	190/7.5
Cutting edge length, mm/"	90/3.5
Blade width, mm/"	40/1.6
Blade thickness, mm/"	5/0.19
Blade material	High-Carbon Steel
Hardness	56-58 HRC
Grind type	Scandi
Bevel angle	30°
Weight (net), g/(oz)	200/7.5
Pcs per carton	6

Wood carving gouges for shaping, hollowing, relief carving, and surface finishing. Available in various sweep profiles, widths, and handle shapes.

Gouges Chisels

- Full-Size •
- Compact •
- Palm-Handled •

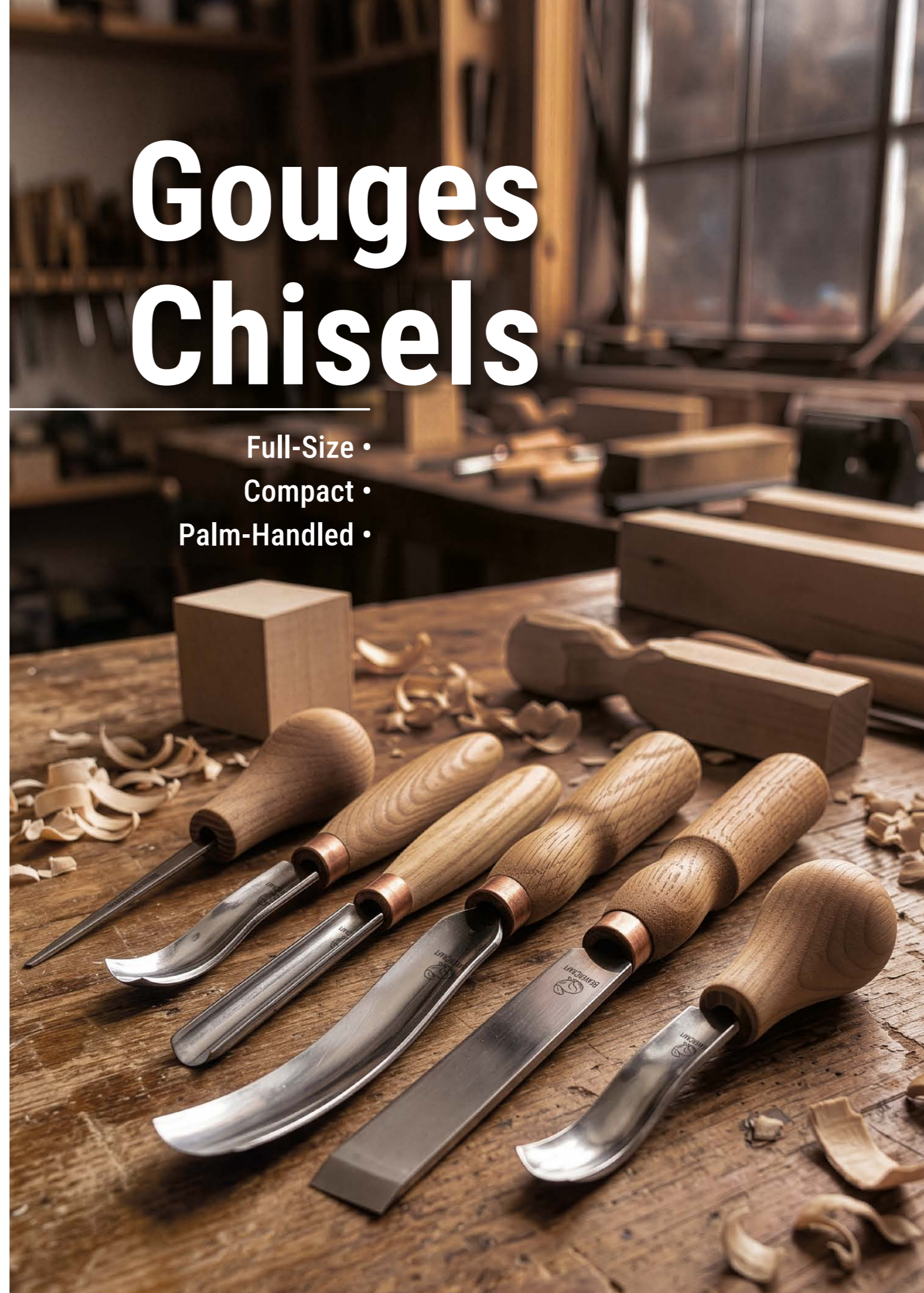

G7L/22 – Full-Size Long Bent Gouge



Total length, mm/"	275/10.8
Handle length, mm/"	150/5.9
Handle material	Oak
Blade length, mm/"	125/4.9
Blade width, mm/"	22/0.9
Blade thickness, mm/"	2/0.08
Blade material	High-Carbon Steel
Hardness	57–59 HRC
Grind type	Chisel
Bevel angle	25°
Weight (net), g/(oz)	135/4.8
Weight (gross), g/(oz)	168/5.9
Pcs per carton	50

G1/10 – Full-Size Straight Flat Chisel

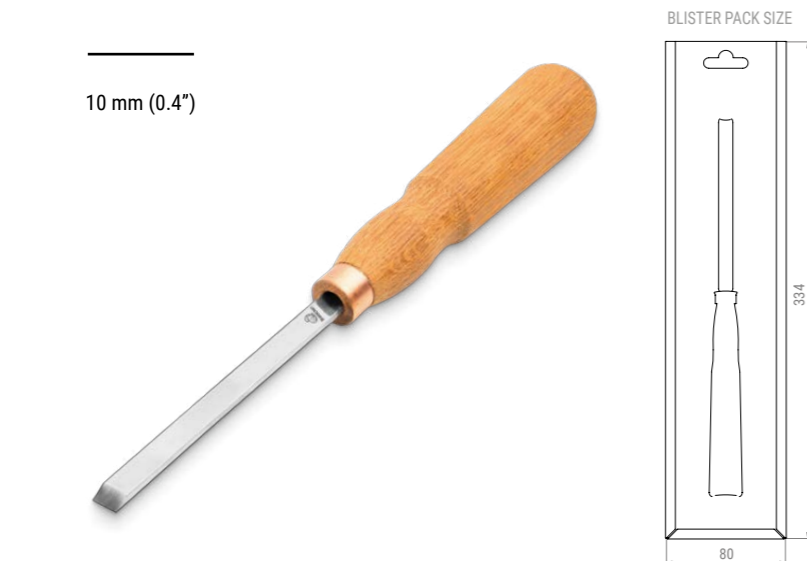

Total length, mm/"	265/10.5
Handle length, mm/"	150/5.9
Handle material	Oak
Blade length, mm/"	115/4.5
Blade width, mm/"	10/0.4
Blade thickness, mm/"	3/0.12
Blade material	High-Carbon Steel
Hardness	57–59 HRC
Grind type	Chisel
Bevel angle	25°
Weight (net), g/(oz)	111/3.9
Weight (gross), g/(oz)	146/5.2
Pcs per carton	50

G1/16 – Full-Size Straight Flat Chisel

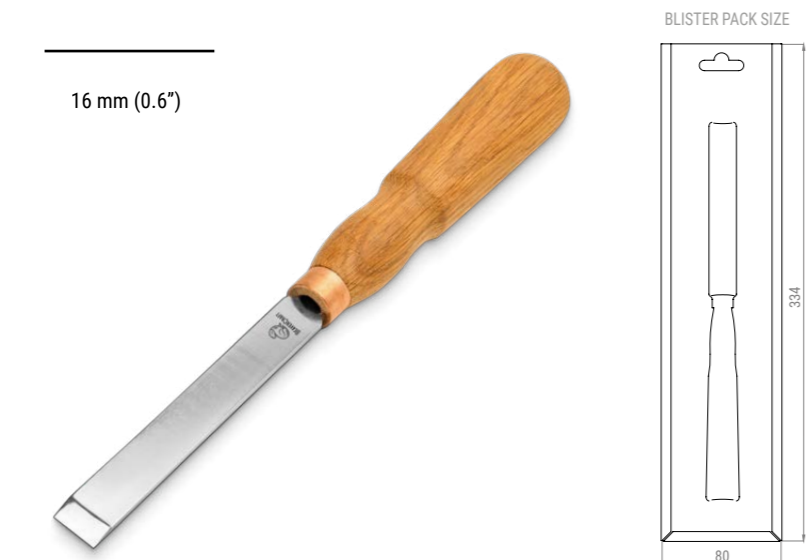

Total length, mm/"	270/10.6
Handle length, mm/"	150/5.9
Handle material	Oak
Blade length, mm/"	120/4.7
Blade width, mm/"	16/0.6
Blade thickness, mm/"	3/0.12
Blade material	High-Carbon Steel
Hardness	57–59 HRC
Grind type	Chisel
Bevel angle	25°
Weight (net), g/(oz)	124/4.4
Weight (gross), g/(oz)	159/5.6
Pcs per carton	50

G1/21 – Full-Size Straight Flat Chisel



Total length, mm/"	270/10.6
Handle length, mm/"	150/5.9
Handle material	Oak
Blade length, mm/"	120/4.7
Blade width, mm/"	21/0.8
Blade thickness, mm/"	3/0.12
Blade material	High-Carbon Steel
Hardness	57–59 HRC
Grind type	Chisel
Bevel angle	25°
Weight (net), g/(oz)	138/4.9
Weight (gross), g/(oz)	171/6
Pcs per carton	50

K1/10 – Compact Straight Flat Chisel



Total length, mm/"	200/7.9
Handle length, mm/"	120/4.7
Handle material	Ash wood
Blade length, mm/"	80/3.1
Blade width, mm/"	10/0.4
Blade thickness, mm/"	2/0.08
Blade material	High-Carbon Steel
Hardness	57–59 HRC
Grind type	Chisel
Bevel angle	25°
Weight (net), g/(oz)	54/1.9
Weight (gross), g/(oz)	81/2.9
Pcs per carton	50

K5/12 – Compact Straight Shallow Gouge



Total length, mm/"	200/7.9
Handle length, mm/"	120/4.7
Handle material	Ash wood
Blade length, mm/"	80/3.1
Blade width, mm/"	12/0.5
Blade thickness, mm/"	2/0.08
Blade material	High-Carbon Steel
Hardness	57–59 HRC
Grind type	Chisel
Bevel angle	25°
Weight (net), g/(oz)	57/2
Weight (gross), g/(oz)	85/3
Pcs per carton	50

K8/08 – Compact Straight Medium Gouge

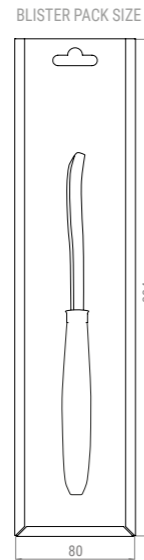
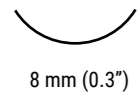

Total length, mm/"	200/7.9
Handle length, mm/"	120/4.7
Handle material	Ash wood
Blade length, mm/"	80/3.1
Blade width, mm/"	8/0.3
Blade thickness, mm/"	2/0.08
Blade material	High-Carbon Steel
Hardness	57–59 HRC
Grind type	Chisel
Bevel angle	25°
Weight (net), g/(oz)	51/1.8
Weight (gross), g/(oz)	79/2.8
Pcs per carton	50

K8a/14 – Compact Short Bent Gouge

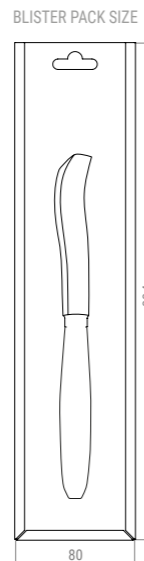
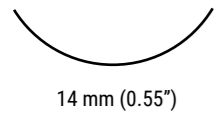

Total length, mm/"	190/7.5
Handle length, mm/"	120/4.7
Handle material	Ash wood
Blade length, mm/"	70/2.5
Blade width, mm/"	14/0.5
Blade thickness, mm/"	2/0.08
Blade material	High-Carbon Steel
Hardness	57–59 HRC
Grind type	Chisel
Bevel angle	25°
Weight (net), g/(oz)	68/2.4
Weight (gross), g/(oz)	96/3.4
Pcs per carton	50

K9/10 – Compact Straight Deep Gouge

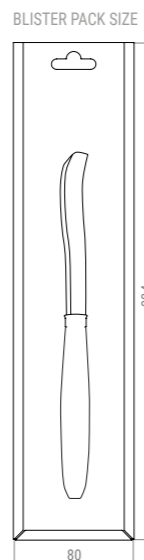
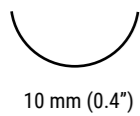

Total length, mm/"	200/7.9
Handle length, mm/"	120/4.7
Handle material	Ash wood
Blade length, mm/"	80/3.1
Blade width, mm/"	10/0.4
Blade thickness, mm/"	2/0.08
Blade material	High-Carbon Steel
Hardness	57–59 HRC
Grind type	Chisel
Bevel angle	25°
Weight (net), g/(oz)	56/2
Weight (gross), g/(oz)	84/3
Pcs per carton	50

K12/02 – Compact Straight V-Tool

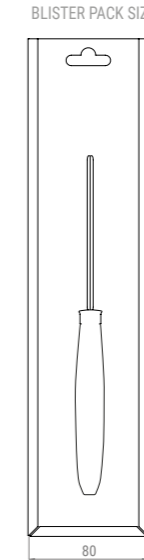

Total length, mm/"	190/7.5
Handle length, mm/"	120/4.7
Handle material	Ash wood
Blade length, mm/"	70/2.5
Blade width, mm/"	2/0.1
Blade thickness, mm/"	1/0.04
Blade material	High-Carbon Steel
Hardness	57–59 HRC
Grind type	Chisel
Bevel angle	20°
Weight (net), g/(oz)	36/1.3
Weight (gross), g/(oz)	62/2.2
Pcs per carton	50

K6L/15 – Compact Long Bent Gouge

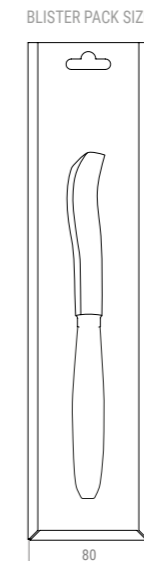
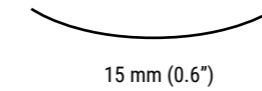

Total length, mm/"	200/7.9
Handle length, mm/"	120/4.7
Handle material	Ash wood
Blade length, mm/"	80/3.1
Blade width, mm/"	15/0.6
Blade thickness, mm/"	2/0.08
Blade material	High-Carbon Steel
Hardness	57–59 HRC
Grind type	Chisel
Bevel angle	25°
Weight (net), g/(oz)	62/2.2
Weight (gross), g/(oz)	90/3.2
Pcs per carton	50

P1/01 – Palm-Handled Straight Chisel

1 mm (0.04")

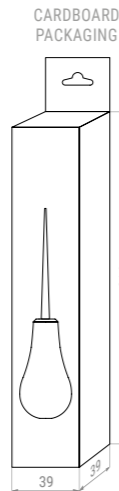

Total length, mm/"	145/5.7
Handle length, mm/"	75/3
Handle material	Ash wood
Blade length, mm/"	70/2.8
Blade width, mm/"	1/0.04
Blade thickness, mm/"	2/0.08
Blade material	High-Carbon Steel
Hardness	57–59 HRC
Grind type	Chisel
Bevel angle	25°
Weight (net), g/(oz)	48/1.7
Weight (gross), g/(oz)	61/2.2
Pcs per carton	50

P1/02 – Palm-Handled Straight Chisel

2 mm (0.08")

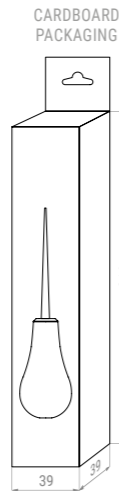

Total length, mm/"	145/5.7
Handle length, mm/"	75/3
Handle material	Ash wood
Blade length, mm/"	70/2.8
Blade width, mm/"	2/0.1
Blade thickness, mm/"	2/0.08
Blade material	High-Carbon Steel
Hardness	57–59 HRC
Grind type	Chisel
Bevel angle	25°
Weight (net), g/(oz)	48/1.7
Weight (gross), g/(oz)	61/2.2
Pcs per carton	50

P1/03 – Palm-Handled Straight Chisel

3 mm (0.12")

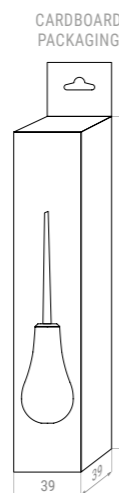

Total length, mm/"	145/5.7
Handle length, mm/"	75/3
Handle material	Ash wood
Blade length, mm/"	70/2.8
Blade width, mm/"	3/0.12
Blade thickness, mm/"	2/0.08
Blade material	High-Carbon Steel
Hardness	57–59 HRC
Grind type	Chisel
Bevel angle	25°
Weight (net), g/(oz)	50/1.8
Weight (gross), g/(oz)	63/2.3
Pcs per carton	50

P1/04 – Palm-Handled Straight Chisel

4 mm (0.16")

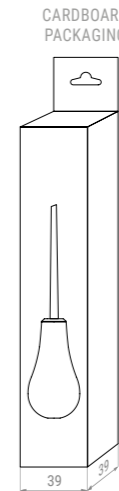

Total length, mm/"	145/5.7
Handle length, mm/"	75/3
Handle material	Ash wood
Blade length, mm/"	70/2.8
Blade width, mm/"	4/0.1
Blade thickness, mm/"	2/0.08
Blade material	High-Carbon Steel
Hardness	57–59 HRC
Grind type	Chisel
Bevel angle	25°
Weight (net), g/(oz)	50/1.8
Weight (gross), g/(oz)	63/2.3
Pcs per carton	50

P1/10 – Palm-Handled Straight Chisel

10 mm (0.4")

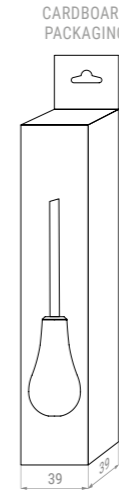

Total length, mm/"	155/6.1
Handle length, mm/"	75/3
Handle material	Ash wood
Blade length, mm/"	80/3.1
Blade width, mm/"	10/0.4
Blade thickness, mm/"	2/0.08
Blade material	High-Carbon Steel
Hardness	57–59 HRC
Grind type	Chisel
Bevel angle	25°
Weight (net), g/(oz)	51/1.8
Weight (gross), g/(oz)	64/2.3
Pcs per carton	50

P5/12 – Palm-Handled Straight Shallow Gouge

12 mm (0.5")

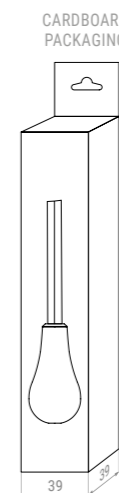

Total length, mm/"	155/6.1
Handle length, mm/"	75/3
Handle material	Ash wood
Blade length, mm/"	80/3.1
Blade width, mm/"	12/0.5
Blade thickness, mm/"	2/0.08
Blade material	High-Carbon Steel
Hardness	57–59 HRC
Grind type	Chisel
Bevel angle	25°
Weight (net), g/(oz)	60/2.1
Weight (gross), g/(oz)	73/2.6
Pcs per carton	50

P8/08 – Palm-Handled Straight Medium Gouge

8 mm (0.31")

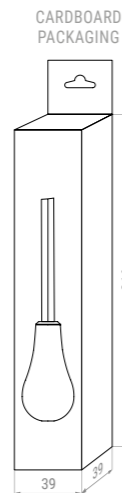

Total length, mm/"	155/6.1
Handle length, mm/"	75/3
Handle material	Ash wood
Blade length, mm/"	80/3.1
Blade width, mm/"	8/0.3
Blade thickness, mm/"	2/0.08
Blade material	High-Carbon Steel
Hardness	57–59 HRC
Grind type	Chisel
Bevel angle	25°
Weight (net), g/(oz)	54/1.9
Weight (gross), g/(oz)	67/2.4
Pcs per carton	50

P9/10 – Palm-Handled Straight Deep Gouge

10 mm (0.4")

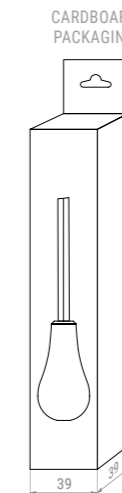

Total length, mm/"	155/6.1
Handle length, mm/"	75/3
Handle material	Ash wood
Blade length, mm/"	80/3.1
Blade width, mm/"	10/0.4
Blade thickness, mm/"	2/0.08
Blade material	High-Carbon Steel
Hardness	57–59 HRC
Grind type	Chisel
Bevel angle	25°
Weight (net), g/(oz)	62/2.2
Weight (gross), g/(oz)	75/2.7
Pcs per carton	50

P8a/14 – Palm-Handled Bent Gouge

14 mm (0.55")

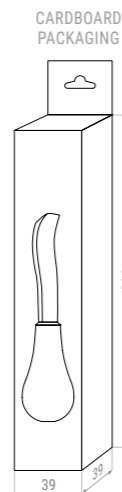

Total length, mm/"	145/5.7
Handle length, mm/"	75/3
Handle material	Ash wood
Blade length, mm/"	70/2.5
Blade width, mm/"	14/0.5
Blade thickness, mm/"	2/0.08
Blade material	High-Carbon Steel
Hardness	57–59 HRC
Grind type	Chisel
Bevel angle	25°
Weight (net), g/(oz)	65/2.3
Weight (gross), g/(oz)	78/2.8
Pcs per carton	50

P12/02 – Palm-Handled V-Tool

2 mm (0.08")

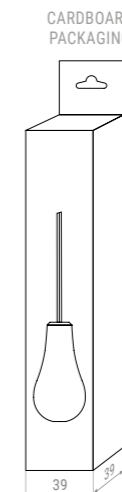

Total length, mm/"	145/5.7
Handle length, mm/"	75/3
Handle material	Ash wood
Blade length, mm/"	70/2.5
Blade width, mm/"	2/0.1
Blade thickness, mm/"	1/0.04
Blade material	High-Carbon Steel
Hardness	57–59 HRC
Grind type	Chisel
Bevel angle	20°
Weight (net), g/(oz)	41/1.5
Weight (gross), g/(oz)	54/1.9
Pcs per carton	50

Tool Sets

Complete wood carving sets assembled for different carving styles and skill levels. They combine various carving tools, stropping accessories, and everything needed to start carving in convenient ready-to-use kits.



S01 – 2-Piece Spoon Carving Knife Set



- Carving Knife**
- C1
- Spoon (Hook) Knife**
- SK1
- Accessories**
- Leather Strop
 - Polishing Compound

Weight (gross): 170 g (6 oz)
Pcs per carton: 50

** Available in right- and left-handed versions*

S02 – 2-Piece Spoon Carving Knife Set



- Carving Knife**
- C8
- Spoon (Hook) Knife**
- SK1
- Accessories**
- Leather Strop
 - Polishing Compound

Weight (gross): 175 g (6.2 oz)
Pcs per carton: 50

** Available in right- and left-handed versions*

S03 – 2-Piece Spoon Carving Knife Set



- Carving Knife**
- C4M
- Spoon (Hook) Knife**
- SK1
- Accessories**
- Leather Strop
 - Polishing Compound

Weight (gross): 180 g (6.4 oz)
Pcs per carton: 50

** Available in right- and left-handed versions*

S04 – 2-Piece Chip Carving Knife Set



- Carving Knives**
- C6
 - C12
- Accessories**
- Leather Strop
 - Polishing Compound

Weight (gross): 175 g (6.2 oz)
Pcs per carton: 50

S05 – 4-Piece Chip Carving Knife Set



- Carving Knives**
- C10S
 - C10
 - C11S
 - C12
- Accessories**
- Tool Roll

Weight (gross): 320 g (11.3 oz)
Pcs per carton: 30

S06 – 3-Piece Wood Carving Knife Set



- Carving Knives**
- C2
 - C6
 - C8
- Accessories**
- Leather Strop
 - Polishing Compound
 - Tool Roll

Weight (gross): 300 g (10.6 oz)
Pcs per carton: 30

S07 – 4-Piece Wood Carving Knife Set



Carving Knives

- C1
- C2
- C3
- C12

Accessories

- Leather Strop
- Polishing Compound

Weight (gross): 320 g (11.3 oz)

Pcs per carton: 30

S08 – 8-Piece Wood Carving Tool Set



Carving Knives

- C1
- C2
- C6
- C7
- C8
- C12

Spoon (Hook) Knives

- SK1
- SK2

Accessories

- Leather Strop
- Polishing Compound
- Tool Roll

Weight (gross): 640 g (22.6 oz)

Pcs per carton: 25

** Available in right- and left-handed versions*

S09 – 4-Piece Wood Carving Knife Set



Carving Knives

- C4M
- C7
- C8

Spoon (Hook) Knife

- SK1

Accessories

- Tool Roll

Weight (gross): 350 g (12.4 oz)

Pcs per carton: 30

** Available in right- and left-handed versions*

S10 – 12-Piece Wood Carving Knife Set



Carving Knives

- C1
- C2
- C3
- C4M
- C5
- C6
- C7
- C8
- C10S
- C11
- C12

Spoon (Hook) Knife

- SK2

Accessories

- Leather Strop
- Polishing Compound
- Tool Roll

Weight (gross): 880 g (31 oz)

Pcs per carton: 25

** Available in right- and left-handed versions*

S11 – 4-Piece Spoon Carving Knife Set



Spoon (Hook) Knives

- SK1
- SK2
- SK2 Long
- SK3 Long

Weight (gross): 600 g (21.2 oz)
The set is packed in 2 individual boxes.

* Available in right- and left-handed versions

S12 – 3-Piece Wood Carving Knife Set



Carving Knives

- C2
- C8
- C12

Weight (gross): 230 g (8.1 oz)
Pcs per carton: 50

S13 – 3-Piece Spoon Carving Knife Set



Carving Knives

- C4M
- C8

Spoon (Hook) Knife

- SK1

Accessories

- Leather Strop
- Polishing Compound
- Cut-Resistant Tape
- Tool Roll

Weight (gross): 340 g (12 oz)
Pcs per carton: 30

* Available in right- and left-handed versions

S14 – 3-Piece Spoon Carving Tool Set



Carving Knife

- C4

Spoon (Hook) Knife

- SK2 Oak

Gouge

- GL7/22

Weight (gross): 300 g (10.6 oz)
Pcs per carton: 30

* Available in right- and left-handed versions

S14m – 3-Piece Spoon Carving Tool Set



Carving Knife

- C4M

Spoon (Hook) Knife

- SK1

Gouge

- K8a/14

Accessories

- Tool Roll

Weight (gross): 300 g (10.6 oz)
Pcs per carton: 30

S15 – 3-Piece Wood Carving Knife Set



Carving Knives

- C6
- C15
- C16

Accessories

- Leather Strop
- Polishing Compound
- Cut-Resistant Tape
- Tool Roll
- Carving Guide Booklet

Weight (gross): 320 g (11.3 oz)
Pcs per carton: 30

S16 – 2-Piece Wood Carving Knife Set with 5 Basswood Blocks



- Carving Knives**
- C6
 - C15
- Wood**
- Basswood Blocks
- Accessories**
- Carving Guide Booklet
- Weight (gross): 400 g (14.1 oz)**
Pcs per carton: 25

S17 – 3-Piece Spoon Carving Knife Set



- Carving Knives**
- C13
 - C15
- Spoon (Hook) Knife**
- SK1
- Accessories**
- Leather Strop
 - Polishing Compound
 - Tool Roll
- Weight (gross): 285 g (10 oz)**
Pcs per carton: 30

** Available in right- and left-handed versions*

S38 – 3-Piece Spoon Carving Tool Set



- Carving Knife**
- C1
- Spoon (Hook) Knife**
- SK1
- Gouge**
- K8a/14
- Accessories**
- Leather Strop
 - Polishing Compound
 - Tool Roll
- Weight (gross): 350 g (12.4 oz)**
Pcs per carton: 30

** Available in right- and left-handed versions*

S43 – 4-Piece Spoon and Kuksa Carving Tool Set



- Carving Knives**
- C3
 - C4
- Spoon (Hook) Knife**
- SK2
- Gouge**
- K6L/15
- Accessories**
- Leather Strop
 - Polishing Compound
 - Tool Roll
- Weight (gross): 440 g (15.5 oz)**
Pcs per carton: 30

** Available in right- and left-handed versions*

S47 – 3-Piece Spoon Carving Tool Set



- Carving Knife**
- C14
- Spoon (Hook) Knife**
- SK5
- Gouge**
- G7L/20
- Accessories**
- Leather Strop
 - Polishing Compound
- Weight (gross): 340 g (12 oz)**
Pcs per carton: 25

S48 – 4-Piece Wood Carving Tool Set



- Carving Knives**
- C1
 - C14
 - C15
- Spoon (Hook) Knife**
- SK1
- Accessories**
- Leather Strop
 - Polishing Compound
 - Tool Roll
- Weight (gross): 440 g (15.5 oz)**
Pcs per carton: 30

** Available in right- and left-handed versions*

S49 – 4-Piece Spoon and Kuksa Carving Set



- Carving Knives**
- C1
 - C11S
- Spoon (Hook) Knife**
- SK2
- Gouge**
- K6L/15
- Accessories**
- Leather Strop
 - Polishing Compound
 - Tool Roll
- Weight (gross): 460 g (16.2 oz)**
Pcs per carton: 30

** Available in right- and left-handed versions*

S50 – 12-Piece Extended Wood Carving Tool Set



- Carving Knives**
- C2
 - C3
 - C4M
 - C6
 - C9
 - C11
 - C14
 - C15
- Gouges, Chisels, V-Tools**
- K8a/14
 - K9/10
 - K1/10
 - K12/02
- Accessories**
- Leather Strop
 - Polishing Compound
 - Tool Roll
- Weight (gross): 710 g (25 oz)**
Pcs per carton: 10

S53 – 10-Piece Spoon Carving Tool Set



- Carving Knives**
- C1M
 - C3
 - C4
 - C13
- Spoon (Hook) Knives**
- SK1 Oak
 - SK2 Oak
 - SK4
 - SK5
- Gouges**
- K8a/14
 - GL7/20
- Accessories**
- Leather Strop
 - Polishing Compound
 - Tool Roll
- Weight (gross): 1100 g (38.8 oz)**
Pcs per carton: 10

S54 – 6-Piece Spoon Carving Tool Set



- Carving Knife**
- C4
- Spoon (Hook) Knives**
- SK2 Oak
 - SK4
 - SK5
- Gouges**
- K8a/14
 - GL7/20
- Accessories**
- Leather Strop
 - Leather Paddle Strop
 - Polishing Compound
- Weight (gross): 870 g (30.7 oz)**
Pcs per carton: 10

S57 – 20-Piece Large Wood Carving Tool Set



Carving Knives

- C2
- C3
- C4
- C6
- C7
- C8
- C11S
- C12
- C14
- C15
- C17p

Spoon (Hook) Knives

- SK1 Oak
- SK2 Oak

Palm Tools

- P1/02
- P1/04
- P12/02
- P5/12
- P8/08
- P8a/14
- P9/10

Wood

- Basswood Blocks

Accessories

- Leather Strop
- Leather Paddle Strop
- Polishing Compounds
- Tool Holder

Weight (gross): 4400 g (155.2 oz)

Pcs per carton: 1



S58 – 6-Piece Wood Carving Knife Set



Carving Knives

- C2
- C3
- C4M
- C13
- C14
- C15

Accessories

- Leather Strop
- Polishing Compound
- Tool Roll

Weight (gross): 490 g (17.3 oz)

Pcs per carton: 10

SC01 – 4-Piece Wood Carving Gouge Chisel Set



Gouges, V-Tools

- K9/10
- K5/12
- K8a/14
- K12/02

Accessories

- Leather Strop
- Polishing Compound
- Tool Roll

Weight (gross): 350 g (12.4 oz)

Pcs per carton: 30

SC02 – 4-Piece Wood Carving Gouge Chisel Set



Gouges, V-Tools

- K9/10
- K5/12
- K8/08
- K12/02

Accessories

- Leather Strop
- Polishing Compound
- Tool Roll

Weight (gross): 410 g (14.5 oz)

Pcs per carton: 30

SC05 – 6-Piece Palm-Handled Gouge Chisel Set in Gift Box



Palm Tools

- P5/12
- P8/08
- P8a/14
- P9/10
- P12/02
- P1/04

Weight (gross): 440 g (15.5 oz)

Pcs per carton: 20

SC03 – 7-Piece Extended Wood Carving Gouge Chisel Set



Gouges, Chisels, V-Tools

- K9/10
- K5/12
- K8/08
- K8a/14
- K6L/15
- K1/10
- K12/02

Accessories

- Leather Strop
- Polishing Compound
- Tool Roll

Weight (gross): 560 g (19.8 oz)

Pcs per carton: 25



Premium Tool Sets

Premium carving tool sets with walnut wood handles and upgraded storage solutions, such as leather roll-up cases, bags, and wooden boxes. Perfect for professional use, workshops, and gift presentation.



S01X Black/Brown – 2-Piece Premium Spoon Carving Set with Walnut Handles and Leather Case



Carving Knife

- C4X Walnut

Spoon (Hook) Knife

- SK5R Walnut

Accessories

- Leather Sheaths
- Leather Strop (Black/Brown)
- Polishing Compound
- Leather Tool Case (Black/Brown)

Weight (gross): 350 g (12.3 oz)

Pcs per carton: 20

S14X – 3-Piece Premium Spoon and Kuksa Carving Tool Set with Walnut Handles and Leather Case



Carving Knife

- C4X Walnut

Spoon (Hook) Knife

- SK5R Walnut

Gouge

- K8a/14 Walnut

Accessories

- Leather Strop
- Polishing Compound
- Leather Tool Case

Weight (gross): 440 g (15.5 oz)

Pcs per carton: 20

S13X – 3-Piece Premium Spoon Carving Knife Set with Walnut Handles and Leather Case



Carving Knives

- C4M Walnut
- C8 Walnut

Spoon (Hook) Knife

- SK5R Walnut

Accessories

- Leather Strop
- Polishing Compound
- Leather Tool Case

Weight (gross): 385 g (13.6 oz)

Pcs per carton: 24

S15X – 3-Piece Premium Wood Carving Knife Set with Walnut Handles and Leather Tool Case



Carving Knives

- C6 Walnut
- C15 Walnut
- C16 Walnut

Accessories

- Leather Strop
- Polishing Compound
- Leather Tool Case

Weight (gross): 375 g (13.2 oz)

Pcs per carton: 24

S18X – 8-Piece Premium Wood Carving Knife Set with Walnut Handles and Leather Tool Roll



- Carving Knives**
- C3 Walnut
 - C4M Walnut
 - C6 Walnut
 - C12 Walnut
 - C15 Walnut
 - C16 Walnut
- Spoon (Hook) Knife**
- SK5R Walnut
- Gouge**
- K8a/14 Walnut
- Accessories**
- Leather Strop
 - Polishing Compound
 - Leather Tool Case
- Weight (gross): 890 g (31.4 oz)**
Pcs per carton: 18

S19X – 3-Piece Premium Whittling Knife Set with Walnut Handles and Leather Tool Case



- Carving Knives**
- C1 Walnut
 - C3 Walnut
 - C4 Walnut
- Accessories**
- Leather Strop
 - Polishing Compound
 - Leather Tool Case
- Weight (gross): 430 g (15 oz)**
Pcs per carton: 20

S50X – 9-Piece Premium Wood Carving Tool Set with Walnut Handles and Leather Bag



- Carving Knives**
- C2 Walnut
 - C3 Walnut
 - C4M Walnut
 - C12 Walnut
 - C15 Walnut
- Spoon (Hook) Knives**
- SK5R Walnut
 - SK4 Walnut
- Gouge**
- K8a/14 Walnut
- Drawknife**
- DK2 Walnut
- Accessories**
- Leather Paddle Strop
 - Set of 3 Polishing Compound
 - Leather Tool Bag
- Weight (gross): 1800 g (63.5 oz)**
Pcs per carton: 10

S13 BOX – 8-Piece Premium Wood Carving Knife Set with Walnut Handles and Leather Tool Roll



Carving Knives

- C4
- C15

Spoon (Hook) Knife

- SK1

Accessories

- Spoon Blank
- Leather Strop
- Polishing Compound
- Book-Style Tool Case
- Carving Guide Booklet

Weight (gross): 410 g (14.5 oz)

Pcs per carton: 16

** Available in right- and left-handed versions*

S07 Book – 4-Piece Premium Wood Carving Knife Set in Wooden Book Case



Carving Knives

- C2
- C3
- C4M
- C12

Accessories

- Leather Strop
- Polishing Compound
- Book-Style Tool Case

Weight (gross): 450 g (15.9 oz)

Pcs per carton: 18

S05 Book – 4-Piece Premium Chip Carving Knife Set in Wooden Book Case



Carving Knives

- C10
- C10S
- C11S
- C12

Accessories

- Leather Strop
- Polishing Compound
- Book-Style Tool Case

Weight (gross): 450 g (15.9 oz)

Pcs per carton: 18

S09 Book – 4-Piece Premium Wood Carving Knife Set in Wooden Book Case



Carving Knives

- C4M
- C7
- C8

Spoon (Hook) Knife

- SK1

Accessories

- Leather Strop
- Polishing Compound
- Book-Style Tool Case

Weight (gross): 450 g (15.9 oz)

Pcs per carton: 18

** Available in right- and left-handed versions*

Premium Tool Sets

S19 Book – 3-Piece Premium Whittling Knife Set in Wooden Book Case



Carving Knives

- C1
- C10S

Spoon (Hook) Knife

- SK1

Gouge

- K8a/14

Accessories

- Leather Strop
- Polishing Compound
- Book-Style Tool Case

Weight (gross): 380 g (13.4 oz)

Pcs per carton: 18

** Available in right- and left-handed versions*

S43 Book – 4-Piece Premium Spoon and Kuksa Carving Tool Set in Wooden Book Case



Carving Knives

- C3
- C4

Spoon (Hook) Knife

- SK2

Gouge

- K6L/15

Accessories

- Leather Strop
- Polishing Compound
- Book-Style Tool Case

Weight (gross): 450 g (15.9 oz)

Pcs per carton: 18

** Available in right- and left-handed versions*



All-in-one DIY craft kits for creative hobbies such as wood carving, leathercraft, pyrography, and sculpting. Include tools, materials, patterns, and accessories required to complete the project, depending on the kit type.

DIY Hobby Kits



DIY01 – Comfort Bird Carving Kit

Ages 14+



What's in the Kit

- C1M Small Whittling Knife
- Basswood Block
- Cherry Block
- Carving Pattern
- Leather Strop & Polishing Compound
- Cut-Resistant Tape
- Sandpaper (5 pcs, assorted grits)
- Beeswax
- Ruler and pencil
- Step-by-Step Booklet
- Video Tutorial

Weight (gross): 600 g (21.2 oz)
Pcs per carton: 20

DIY03 – Wizard Carving Kit

Ages 14+



What's in the Kit

- C2 Wood Carving Knife
- 3 Basswood Blocks
- Carving Pattern
- Pencil
- Cut-Resistant Tape
- Sandpaper P1500 (3 pcs)
- Step-by-Step Booklet
- Video Tutorial

Weight (gross): 300 g (10.6 oz)
Pcs per carton: 30

DIY02 – Dala Horse Carving Kit

Ages 14+



What's in the Kit

- C14 Whittling Knife
- Horse Basswood Blank
- Brush & Paints
- Leather Strop & Polishing Compound
- Cut-Resistant Tape
- Sandpaper P150 (2 pcs)
- Ruler and pencil
- Step-by-Step Booklet
- Video Tutorial

Weight (gross): 500 g (17.6 oz)
Pcs per carton: 20

DIY04 – Celtic Spoon Carving Kit

Ages 14+



What's in the Kit

- C13 Whittling Knife
- SK1 Spoon Carving Knife
- Basswood Spoon Blank
- Carving Pattern
- Leather Strop & Polishing Compound
- Cut-Resistant Tape
- Sandpaper (5 pcs, assorted grits)
- Ruler and pencil
- Step-by-Step Booklet
- Video Tutorial
- Adhesive Bandage

Weight (gross): 500 g (17.6 oz)
Pcs per carton: 20

DIY05 – Bear Carving Kit

Ages 14+



What's in the Kit

- C17P Universal Detail Knife
- 2 Basswood Blocks
- Carving Pattern
- Leather Strop & Polishing Compound
- Cut-Resistant Tape
- Sandpaper (3 pcs)
- Pencil
- Step-by-Step Booklet
- Video Tutorial

Weight (gross): 550 g (19.4 oz)
Pcs per carton: 20

DIY06 – Santa Carving Kit

Ages 14+



What's in the Kit

- C16 Big Roughing Knife
- 2 Basswood Blocks
- Carving Pattern
- Leather Strop & Polishing Compound
- Cut-Resistant Tape
- Pencil, Brush & Paints
- Step-by-Step Booklet
- Video Tutorial

Weight (gross): 550 g (19.4 oz)
Pcs per carton: 20

DIY07 – Walnut Kuksa Carving Kit

Ages 14+



What's in the Kit

- C4 Whittling Knife
- K8a/14 Compact Short Bent Gouge
- Walnut Kuksa Blank
- Leather Strop & Polishing Compound
- Cut-Resistant Tape
- Sandpaper (5 pcs, assorted grits)
- Beeswax & Mineral Oil
- Leather Lace Strip
- Step-by-Step Booklet
- Video Tutorial

Weight (gross): 600 g (21.2 oz)
Pcs per carton: 20

DIY08 – Spruce Tree Carving Kit

Ages 14+



What's in the Kit

- C1 Kids' Whittling Knife with Leather Sheath
- 2 Basswood Blocks
- Cut-Resistant Tape
- Sandpaper P1500 (3 pcs)
- Pencil, Brush & Paints
- Step-by-Step Booklet
- Video Tutorial

Weight (gross): 250 g (8.8 oz)
Pcs per carton: 36

DIY09 – Family Fun Wood Carving Kit

Ages 14+



What's in the Kit

- C1 Kids' Whittling Knife with Leather Sheath
- C4 Whittling Sloyd Knife with Leather Sheath
- 2 Basswood Blocks
- Cut-Resistant Tape
- Sandpaper (12 pcs, assorted grits)
- 2 Pencils, 2 Brushes & Paints
- Step-by-Step Booklet
- Video Tutorial

Weight (gross): 580 g (20.4 oz)
Pcs per carton: 20

DIY10 – Wooden Clogs Carving Kit

Ages 14+



What's in the Kit

- C4M Whittling Knife
- K8a/14 Compact Short Bent Gouge
- 2 Basswood Blocks
- Carving Pattern
- Leather Strop & Polishing Compound
- Cut-Resistant Tape
- Sandpaper (6 pcs)
- Beeswax
- Ruler and pencil
- Step-by-Step Booklet
- Video Tutorial

Weight (gross): 640 g (22.6 oz)
Pcs per carton: 20

DIY11 – Sauna Ladle Carving Kit

Ages 14+



What's in the Kit

- C4 Whittling Sloyd Knife
- G7L/22 Long Bent Gouge
- B10 Basswood Spoon Blank
- Carving Pattern
- Leather Strop & Polishing Compound
- Cut-Resistant Tape
- Sandpaper (6 pcs)
- Linseed Oil
- Ruler and pencil
- Step-by-Step Booklet
- Video Tutorial

Weight (gross): 800 g (28.2 oz)
Pcs per carton: 12

DIY12 – Standing Bear Carving Kit

Ages 14+



What's in the Kit

- C16 Big Roughing Knife
- 2 Basswood Blocks
- Leather Strop & Polishing Compound
- Cut-Resistant Tape
- 3 Pieces of Sandpaper
- Linseed Oil
- Ruler and pencil
- Step-by-Step Guide
- Carving Pattern

Weight (gross): 550 g (19.4 oz)
Pcs per carton: 20

DIY – Christmas Ornament – Chip Carving Kit

Ages 14+



What's in the Kit

- C12 Chip Carving Knife
- 3 Basswood Blanks
- 15 Carving Patterns
- Practice Board & Training Pattern
- Brushes & Paints
- Non-slip mat
- Leather Strop & Polishing Compound
- Cut-Resistant Tape
- Sandpaper P320 (3 pcs)
- Carbon Paper
- Hooks & String
- Ruler and pencil
- Step-by-Step Booklet
- Video Tutorial

Weight (gross): 310 g (10.9 oz)
Pcs per carton: 30

DIY – Hoppy Bunnies Wood Carving Kit

Ages 14+



What's in the Kit

- C16 Roughing Knife
- 2 Basswood Blocks
- Carving Patterns
- Leather Strop & Polishing Compound
- Cut-Resistant Tape
- Sandpaper
- Carbon Paper
- Pencil, Brush & Paints
- Step-by-Step Booklet
- Video Tutorial

Weight (gross): 500 g (17.6 oz)
Pcs per carton: 20

DIY – Ghost Wood Carving Kit

Ages 14+



What's in the Kit

- C2 Wood Carving Knife
- 3 Basswood Blocks
- Patterns
- Leather Strop & Polishing Compound
- Cut-Resistant Tape
- Sandpaper P220
- Carbon Paper
- Pencil, Brush & Paints
- Step-by-Step Booklet
- Video Tutorial

Weight (gross): 480 g (17 oz)
Pcs per carton: 20

DIY-P-Coasters – Pyrography Kit

Ages 14+



* ⚠️ EU Plug / US Plug

What's in the Kit

- 30W Pyrography Pen
- 2 Interchangeable Tips
- Stand for Pyrography Pen
- 3 Wooden Coasters (Alder or Basswood)
- Practice Board – for warm-up and experimenting
- Ready-to-Use Design Templates (A4 Sheet)
- Graphite Transfer Paper
- Pencil
- Sandpaper (3 pcs)
- Wood Finishing Wax
- Microfiber Cloth
- Safety Glasses
- Masking Tape
- Step-by-Step Instructions

Weight (gross): 550 g (19.4 oz)
Pcs per carton: 14

- Step-by-Step Video Tutorial
- 90+ Patterns to Customize Your Design
- Add Your Personalization

DIY-P-Key Holder – Pyrography Kit

Ages 14+



* ⚠️ EU Plug / US Plug

What's in the Kit

- 30W Pyrography Pen
- 2 Interchangeable Tips
- Stand for Pyrography Pen
- Triangular Plywood Base
- Alder Wood Holder with Slot
- Practice Board – for testing and training
- Ready-to-Use Design Templates (A4 Sheet)
- Graphite Transfer Paper
- Pencil
- Sandpaper (3 pcs)
- Wood Finishing Wax
- Microfiber Cloth
- Safety Glasses
- Screwdriver
- Masking Tape
- Screw Hooks for Keys (4 pcs)
- Round Keyhole Hangers (2 pcs)
- Step-by-Step Instructions

Weight (gross): 700 g (24.7 oz)
Pcs per carton: 14

- Step-by-Step Video Tutorial
- 60+ Patterns to Customize Your Design
- Add Your Personalization

DIY-P-Clock – Pyrography Kit

Ages 14+



* ⚠️ EU Plug / US Plug

What's in the Kit

- Wooden Clock Face (Ø28 cm, 8 mm thick)
- Practice Board
- 30W Pyrography Pen
- 2 Interchangeable Tips
- Ready-to-Use Design Templates (A3 Sheet)
- Graphite Transfer Paper
- Sandpaper (3 pcs)
- Pencil
- Clock Mechanism with Hands
- Wood Finishing Wax
- Step-by-Step Instructions

Weight (gross): 850 g (30 oz)
Pcs per carton: 12

- Step-by-Step Video Tutorial
- 20+ Patterns to Customize Your Design
- Add Your Personalization

DIY-L-Glasses CASE – Leather Crafting Kit

Ages 14+



What's in the Kit

Tools:

- Pricking Irons (2 sizes)
- Thread & Needle
- Hammer
- Punching Board
- Sandpaper
- Microfiber Cloth
- Masking Tape
- Scissors
- Ruler

Materials and Components:

- Pre-cut Leather Piece
- Paper Templates
- Waxed Thread
- Leather Patina Cream
- Design Templates for Customization & Personalization
- Step-by-Step Instructions

Bonus – “Beaver Tail” Keychain

Weight (gross): 590 g (20.8 oz)
Pcs per carton: 25

- Step-by-Step Video Tutorial
- 20+ Patterns to Customize Your Design
- Add Your Personalization

DIY-L-WALLET – Leather Crafting Kit

Ages 14+



Color:
Forest Brown • **Burgundy Rose** • **Black Grey**

What's in the Kit

Tools:

- Pricking Irons (2 sizes)
- Thread & Needle
- Hammer
- Punching Board
- Sandpaper
- Microfiber Cloth
- Masking Tape
- Scissors
- Ruler

Materials and Components:

- Pre-cut Leather Piece
- Paper Templates
- Waxed Thread
- Leather Patina Cream
- Design Templates for Customization & Personalization
- Step-by-Step Instructions

Bonus – “Beaver Tail” Keychain

Weight (gross): 590 g (20.8 oz)
Pcs per carton: 25

- Step-by-Step Video Tutorial
- 50+ Patterns to Customize Your Design
- Add Your Personalization

DIY-L-BRACELETS SET – Leather Crafting Kit

Ages 14+



What's in the Kit

Tools:

- Scissors
- Pricking Irons (2 sizes)
- Hammer
- Punching Board
- Sandpaper
- Microfiber Cloth
- Masking Tape

Materials and Components:

- 3 Pre-cut Leather Pieces
- Leather Laces
- Button Studs (2 pcs)
- Wooden Elements for Personalization
- Leather Patina Cream
- Design Templates for Customization & Personalization
- Step-by-Step Instructions

Weight (gross): 520 g (18.3 oz)
Pcs per carton: 25

- Step-by-Step Video Tutorial
- 10+ Patterns to Customize Your Design
- Add Your Personalization

DIY-Nefertiti – Sculpting Kit

Ages 14+



What's in the Kit

- Plaster block
- Chisel
- Wooden mallet
- Protective craft paper
- Marker
- Sticker pack

Weight (gross): 1000 g (35.3 oz)
Pcs per carton: 20

DIY-David – Sculpting Kit

Ages 14+



What's in the Kit

- Plaster block
- Chisel
- Wooden mallet
- Protective craft paper
- Marker
- Sticker pack

Weight (gross): 1000 g (35.3 oz)
Pcs per carton: 20

DIY-Venus de Milo – Sculpting Kit

Ages 14+



What's in the Kit

- Plaster block
- Chisel
- Wooden mallet
- Protective craft paper
- Marker
- Sticker pack

Weight (gross): 1150 g (40.5 oz)
Pcs per carton: 20

DIY-Terracotta Warrior – Sculpting Kit

Ages 14+



What's in the Kit

- Plaster block
- Chisel
- Wooden mallet
- Protective craft paper
- Marker
- Sticker pack

Weight (gross): 1000 g (35.3 oz)
Pcs per carton: 20

Axes

Hand-forged axes, hatchets, and adzes for woodworking and outdoor use. The range includes carving and bushcraft hatchets, splitting axes, felling axes, and replacement axe heads and handles.

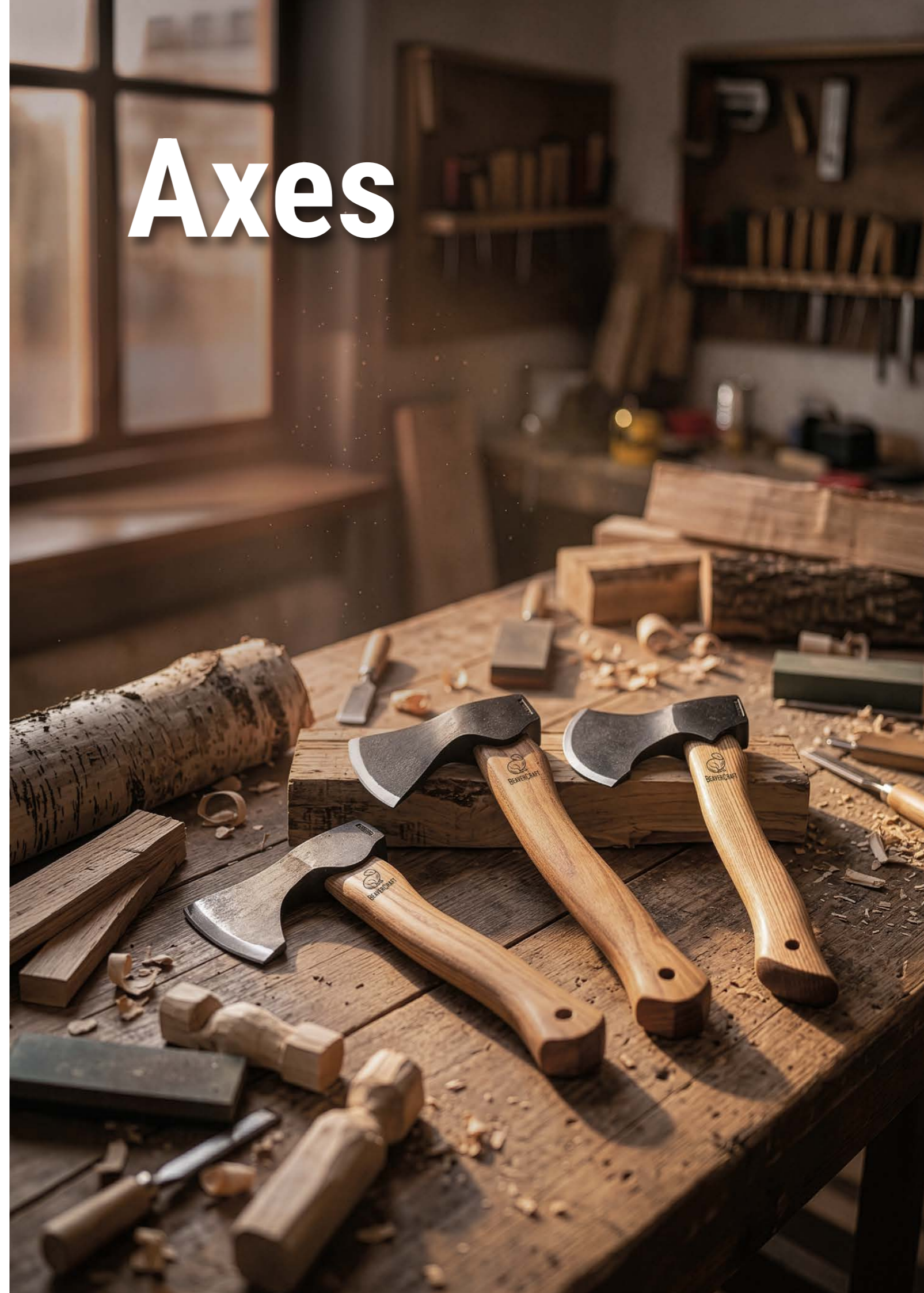

AX1 – Compact Bushcraft Carving Hatchet

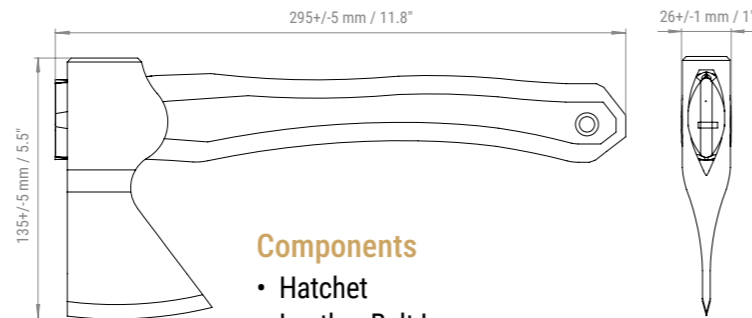

Components

- Hatchet
- Leather Belt Loop
- Leather Sheath

Steel material	High-Carbon Steel
Hardness	56–58 HRC (Rockwell)
Grind type	Convex
Handle material	Ash wood
Sheath material	Cowhide leather
Weight (net), g/(oz)	730/25.7
Weight (gross), g/(oz)	820/29
Pcs per carton	22

AX2 – Compact Wood Carving Adze

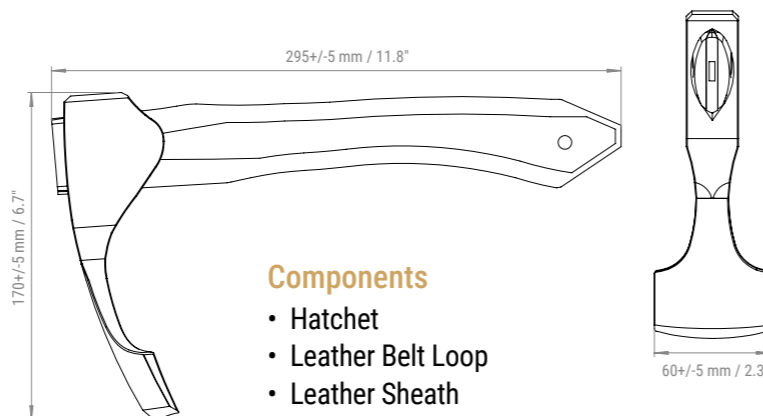

Components

- Hatchet
- Leather Belt Loop
- Leather Sheath

Steel material	High-Carbon Steel
Hardness	56–58 HRC (Rockwell)
Grind type	Convex
Handle material	Ash wood
Sheath material	Cowhide leather
Weight (net), g/(oz)	820/29
Weight (gross), g/(oz)	1035/36.5
Pcs per carton	12

AX3 – Woodcraft Bushcraft Splitting Hatchet

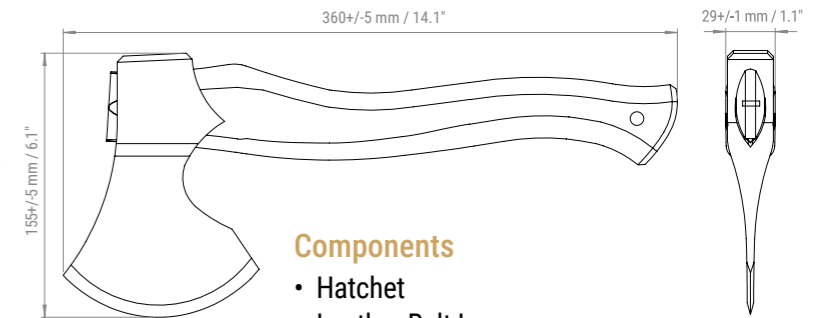

Components

- Hatchet
- Leather Belt Loop
- Leather Sheath

Steel material	High-Carbon Steel
Hardness	56–58 HRC (Rockwell)
Grind type	Convex
Handle material	Ash wood
Sheath material	Cowhide leather
Weight (net), g/(oz)	1030/36.3
Weight (gross), g/(oz)	1140/40.2
Pcs per carton	18

AX4 – Universal Forest Felling Axe

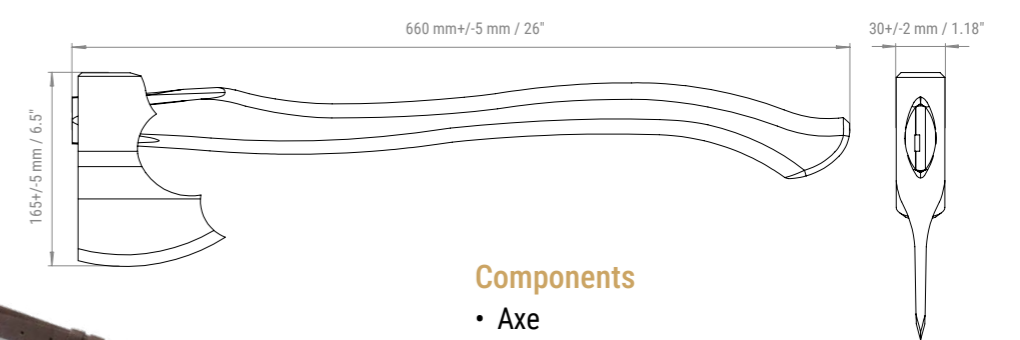

Components

- Axe
- Leather Shoulder Sling
- Leather Sheath

Steel material	High-Carbon Steel
Hardness	56–58 HRC (Rockwell)
Grind type	Convex
Handle material	Ash wood
Sheath material	Cowhide leather
Weight (net), g/(oz)	1600/56.4
Weight (gross), g/(oz)	1800/63.5
Pcs per carton	14

Axes

AX5 – Chopping Hewing Axe

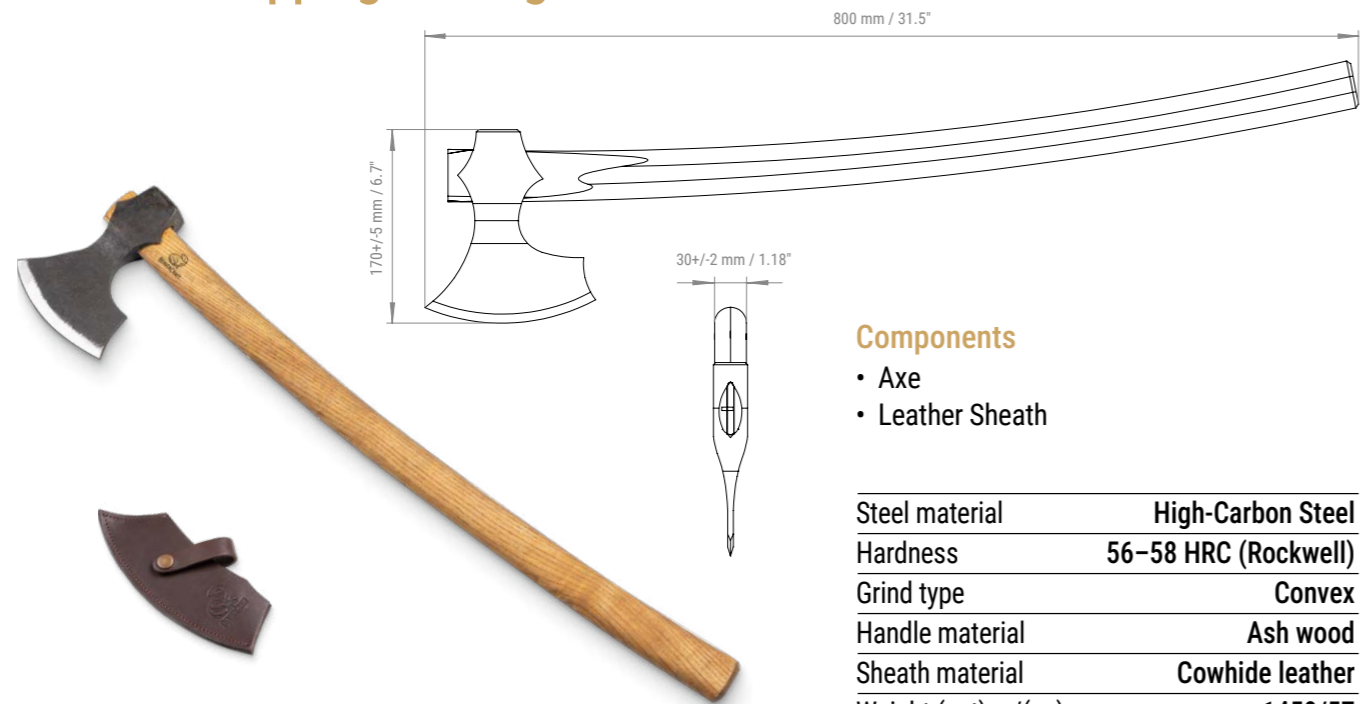

Components

- Axe
- Leather Sheath

Steel material	High-Carbon Steel
Hardness	56–58 HRC (Rockwell)
Grind type	Convex
Handle material	Ash wood
Sheath material	Cowhide leather
Weight (net), g/(oz)	1450/57
Weight (gross), g/(oz)	1770/62.4
Pcs per carton	14

AX6 – Compact Long-Bearded Bushcraft Hatchet



Components

- Hatchet
- Leather Belt Loop
- Leather Sheath

Steel material	High-Carbon Steel
Hardness	56–58 HRC (Rockwell)
Grind type	Convex
Handle material	Ash wood
Sheath material	Cowhide leather
Weight (net), g/(oz)	880/31
Weight (gross), g/(oz)	970/34.2
Pcs per carton	22



Wood

Wood carving materials, including carving blocks, spoon blanks, kuksa blanks, carving boards, and pre-cut animals. Available in different wood species, dimensions, and project formats.

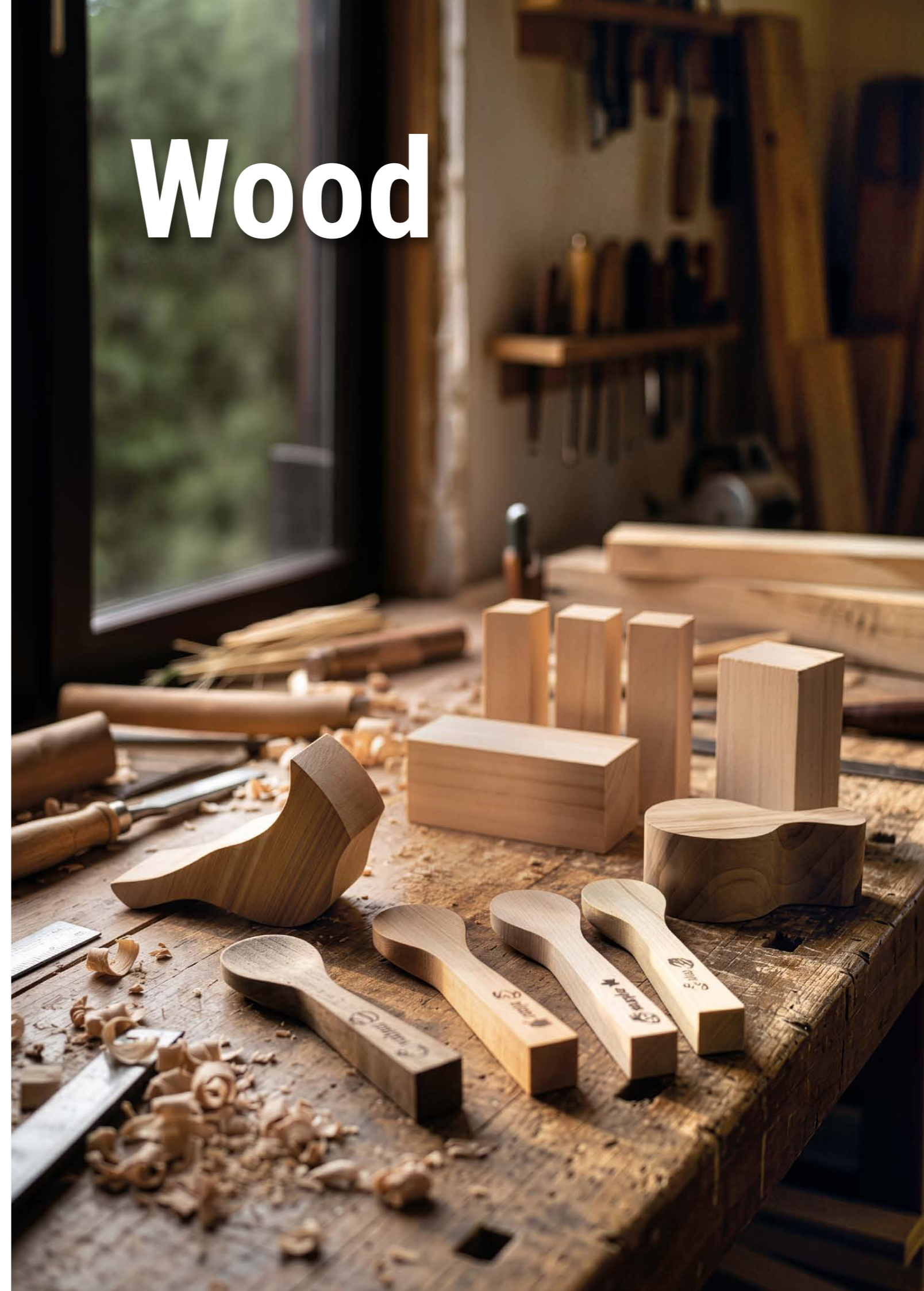

BW1 – Set of Basswood/Walnut Carving Blocks – 5 pcs

• Basswood

• Walnut



1 piece, mm/"	50 x 50 x 100 (2 x 2 x 4)
4 pieces, mm/"	25 x 25 x 100 (1 x 1 x 4)
Weight (gross), g/(oz)	Basswood 310/11
Weight (gross), g/(oz)	Walnut 355/12.5
Pcs per carton	Basswood 39
Pcs per carton	Walnut 39

BW7 – Set of Basswood Carving Blocks – 7 pcs

• Basswood

• Walnut



1 piece, mm/"	50 x 50 x 100 (2 x 2 x 4)
6 pieces, mm/"	25 x 25 x 100 (1 x 1 x 4)
Weight (gross), g/(oz)	Basswood 345/12.2
Weight (gross), g/(oz)	Walnut 465/16.4
Pcs per carton	Basswood 45
Pcs per carton	Walnut 45

BW10 – Set of Basswood/Walnut/Alder Carving Blocks – 10 pcs

• Basswood

• Walnut



2 pieces, mm/"	50 x 50 x 150 (2 x 2 x 6)
8 pieces, mm/"	25 x 25 x 150 (1 x 1 x 6)
Weight (gross), g/(oz)	Basswood 950/33.5
Weight (gross), g/(oz)	Walnut 1055/37.2
Weight (gross), g/(oz)	Alder 850/30
Pcs per carton	Basswood 20
Pcs per carton	Walnut 18
Pcs per carton	Alder 20

BW12 – Set of Basswood Carving Blocks – 12 pcs

• Basswood



2 pieces, mm/"	50 x 50 x 150 (2 x 2 x 4)
4 pieces, mm/"	25 x 25 x 100 (1 x 1 x 4)
6 pieces, mm/"	25 x 25 x 100 (1 x 1 x 6)
Weight (gross), g/(oz)	Basswood 950/33.5
Pcs per carton	Basswood 20

BW16 – Set of Basswood Carving Blocks – 16 pcs

• Basswood



16 pieces, mm/"	25 x 25 x 100 (1 x 1 x 6)
Weight (gross), g/(oz)	Basswood 950/33.5
Pcs per carton	Basswood 20

BW18 – Set of Basswood Carving Blocks – 18 pcs

• Basswood



6 pieces, mm/"	50 x 50 x 50 (2 x 2 x 2)
12 pieces, mm/"	25 x 25 x 100 (1 x 1 x 4)
Weight (gross), g/(oz)	Basswood 880/31
Pcs per carton	Basswood 20

BW19 – Set of Basswood Carving Blocks – 19 pcs

• Basswood



3 pieces, mm/"	50 x 50 x 100 (2 x 2 x 4)
16 pieces, mm/"	25 x 25 x 100 (1 x 1 x 4)
Weight (gross), g/(oz)	965/34.1
Pcs per carton	20

BW1- Large – Large Basswood Carving Block

• Basswood



1 piece, mm/"	100 x 100 x 250 (4 x 4 x 10)
Weight (gross), g/(oz)	1420/50.1
Pcs per carton	12

BB2 – Spoon Carving Blanks Set

• Basswood • Cherry • Walnut • Mulberry



4 pieces

Total length, mm/"	165/6.5
Handle length, mm/"	115/4.5
Handle width, mm/"	22/0.8
Spoon width, mm/"	40/1.5
Spoon thickness, mm/"	16/0.6
Weight (gross), g/(oz)	160/5.6
Pcs per carton	80

BB3 – Spoon Carving Blanks Set

• Elm • Alder • Walnut • Maple



4 pieces

Total length, mm/"	165/6.5
Handle length, mm/"	115/4.5
Handle width, mm/"	22/0.8
Spoon width, mm/"	40/1.5
Spoon thickness, mm/"	16/0.6
Weight (gross), g/(oz)	175/6.2
Pcs per carton	80

B1 – Spoon Carving Blank

• Basswood



Total length, mm/"	260/10.2
Spoon width, mm/"	65/2.6
Spoon thickness, mm/"	40/1.5
Weight (gross), g/(oz)	170/6
Pcs per carton	50

B2 – Leaf Spoon Carving Blank

• Basswood



Total length, mm/"	195/7.7
Spoon width, mm/"	45/1.8
Total height, mm/"	20/0.7
Handle width, mm/"	30/1.2
Handle length, mm/"	130/5.1
Weight (gross), g/(oz)	45/1.6
Pcs per carton	6

B3 – Kuksa Carving Blank

• Basswood

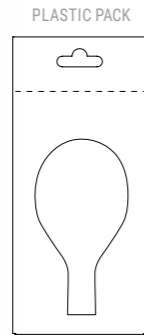

Total length, mm/"	135/5.3
Blank width, mm/"	77/3
Blank thickness, mm/"	50/2
Weight (gross), g/(oz)	200/7.1
Pcs per carton	6

B_Kuksa – Carving Blank

• Walnut

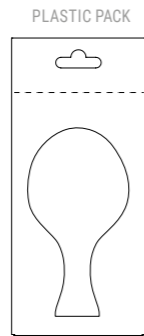

Total length, mm/"	150/5.9
Handle length, mm/"	65/2.6
Blank thickness, mm/"	50/2
Blank width, mm/"	85/3.3
Weight (gross), g/(oz)	280/9.9
Pcs per carton	6

B5 – Spoon Carving Blank

• Basswood

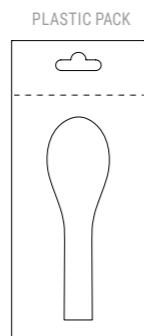

Total length, mm/"	160/6.3
Blank width, mm/"	34/1.3
Blank thickness, mm/"	16/0.6
Weight (gross), g/(oz)	30/1.1
Pcs per carton	6

B6 – Spoon Carving Blank

• Basswood • Cherry • Mulberry • Walnut

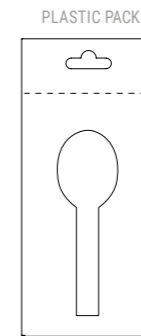

Total length, mm/"	150/6
Blank width, mm/"	50/2
Blank thickness, mm/"	20/0.8
Weight (gross), g/(oz)	Basswood 50/1.8
Weight (gross), g/(oz)	Cherry 50/1.8
Weight (gross), g/(oz)	Mulberry 60/2.1
Weight (gross), g/(oz)	Walnut 50/1.8
Pcs per carton	6

B7 – Spoon Carving Blank

• Basswood • Cherry • Mulberry • Walnut

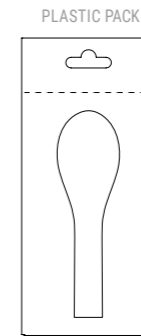

Total length, mm/"	165/6.5
Blank width, mm/"	50/2
Blank thickness, mm/"	20/0.8
Weight (gross), g/(oz)	Basswood 55/1.9
Weight (gross), g/(oz)	Cherry 70/2.5
Weight (gross), g/(oz)	Mulberry 70/2.5
Weight (gross), g/(oz)	Walnut 65/2.3
Pcs per carton	6

B8 – Spoon Carving Blank

• Basswood • Cherry • Walnut

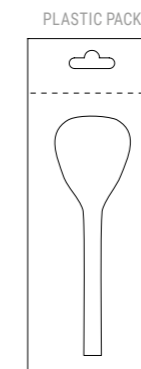

Total length, mm/"	265/10.4
Blank width, mm/"	70/2.8
Blank thickness, mm/"	25/1
Weight (gross), g/(oz)	Basswood 110/3.9
Weight (gross), g/(oz)	Cherry 135/4.8
Weight (gross), g/(oz)	Walnut 160/5.6
Pcs per carton	6

B9 – Spoon Carving Blank

• Basswood • Cherry • Walnut

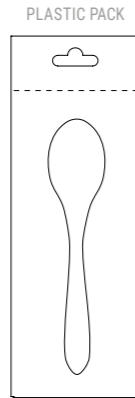

Total length, mm/"	280/11
Blank width, mm/"	50/2
Blank thickness, mm/"	25/1
Weight (gross), g/(oz)	Basswood 100/3.5
Weight (gross), g/(oz)	Cherry 110/3.9
Weight (gross), g/(oz)	Walnut 130/4.6
Pcs per carton	6

B10 – Long Handle Spoon Carving Blank

• Basswood • Cherry • Walnut

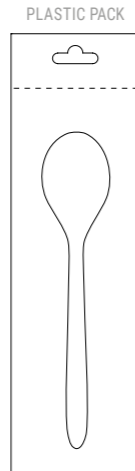

Total length, mm/"	400/15.7
Blank width, mm/"	70/2.8
Blank thickness, mm/"	25/1
Weight (gross), g/(oz)	Basswood 165/5.8
Weight (gross), g/(oz)	Cherry 190/6.7
Weight (gross), g/(oz)	Walnut 260/9.2
Pcs per carton	6

B11 – Spatula Spoon Carving Blank

• Basswood • Cherry • Walnut

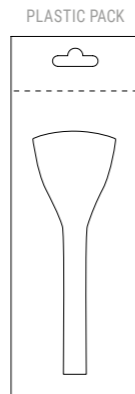

Total length, mm/"	275/10.8
Blank width, mm/"	75/3
Blank thickness, mm/"	10/0.4
Weight (gross), g/(oz)	Basswood 80/2.8
Weight (gross), g/(oz)	Cherry 85/3
Weight (gross), g/(oz)	Walnut 110/3.9
Pcs per carton	6

Bird_Cardinal – Cardinal Bird Carving Blank

• Basswood



Total length, mm/"	145/5.7
Blank width, mm/"	85/3.3
Blank height, mm/"	50/2
Weight (gross), g/(oz)	130/4.6
Pcs per carton	6

Bird_Owl – Owl Bird Carving Blank

• Basswood

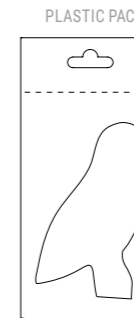

Total length, mm/"	100/4
Blank width, mm/"	70/2.8
Blank height, mm/"	50/2
Weight (gross), g/(oz)	110/3.9
Pcs per carton	6

Bird_Toucan – Toucan Bird Carving Blank

• Basswood

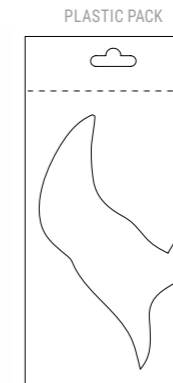

Total length, mm/"	190/7.5
Blank width, mm/"	105/4.1
Blank height, mm/"	50/2
Weight (gross), g/(oz)	175/6.2
Pcs per carton	6

Wood

BP_100x250 – Basswood Board for Chip Carving & Relief Carving

• Basswood



Total length, mm/"	250/10
Blank width, mm/"	100/4
Blank thickness, mm/"	20/0.8
Weight (gross), g/(oz)	265/9.3
Pcs per carton	6

BP_130x250 – Basswood Board for Chip Carving & Relief Carving

• Basswood



Total length, mm/"	250/10
Blank width, mm/"	130/5.1
Blank thickness, mm/"	20/0.8
Weight (gross), g/(oz)	370/13.1
Pcs per carton	6

BP_210x300 – Basswood Board for Chip Carving & Relief Carving

• Basswood



Total length, mm/"	300/11.8
Blank width, mm/"	210/8.3
Blank thickness, mm/"	20/0.8
Weight (gross), g/(oz)	660/23.3
Pcs per carton	6

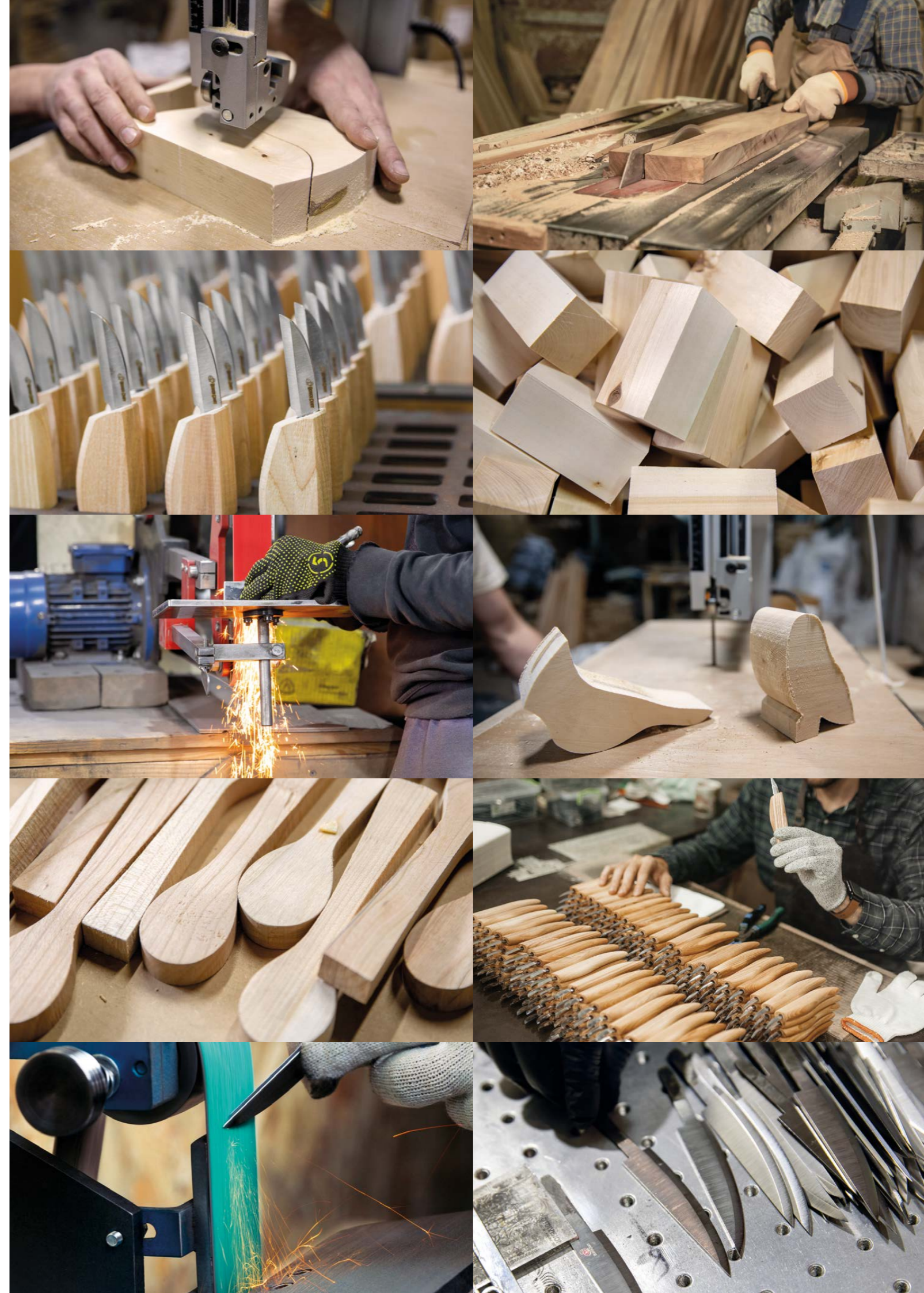

Sharpening

Sharpening and maintenance tools, including leather strops, polishing compounds, stropping kits, and other accessories designed to maintain blade sharpness and extend tool life.



LS1P1 – Double-Sided Leather Paddle Strop with Polishing Compound



Total length, mm/"	380/15
Length of the leatherworking part, mm/"	230/9.1
Working width of the leather, mm/"	80/3.1
Thickness of the strop, mm/"	20/0.7
Material	Ash wood, leather

Items included

- Strop 1 pcs
- Polishing Compound - 1 pcs

Weight (gross): 485 g (17.1 oz)

Pcs per carton: 29

LS2P1 – Double-Sided Leather Strop with Polishing Compound



Length, mm/"	200/8
Width, mm/"	75/3
Thickness, mm/"	4-5/0.16-0.2
Material	Leather
Color	Light brown

Items included

- Strop 1 pcs
- Polishing Compound - 1 pcs

Weight (gross): 75 g (2.6 oz)

Pcs per carton: 50/100

LS3 – Extended Double-Sided Leather Strop with Compound



Length, mm/"	350/13.8
Width, mm/"	50/2
Thickness, mm/"	2-4/0.08-0.16
Material	Leather
Color	Black
Weight (gross), g/(oz)	150/5.36
Pcs per carton	6

LS5P1 – Double-Sided Leather Paddle Strop for Hook Knives and Gouges with Polishing Compound



Total length, mm/"	310/12.2
Handle length, mm/"	125/4.9
Strop width, mm/"	70/2.7
Strop thickness, mm/"	22/0.9
Material	Ash wood, leather
Inner radius, mm/"	22/0.8
Outer radius, mm/"	10/0.3

Items included

- Strop 1 pcs
- Sandpaper P600 1 pcs
- Sandpaper P1200 1 pcs
- Polishing Compound - 1 pcs

Weight (gross): 300 g (10.6 oz)

Pcs per carton: 50

LS6P1 – Double-Sided Leather Paddle Strop with Polishing Compound



Length of the leather part, mm/"	240/9.5
Total length, mm/"	370/14.6
Total width, mm/"	50/2
Surface	Cowhide leather
Material	Ash wood

Items included

- Strop 1 pcs
- Polishing Compound - 1 pcs

Weight (gross): 270 g (9.5 oz)

Pcs per carton: 64

LS7P03 – Double-Sided Leather Strop with 3 Polishing Compounds



Length, mm/"	310/12.2
Width, mm/"	75/2.9
Thickness, mm/"	4-5/0.16-0.2
Material	Cowhide leather

Items included

- Strop 1 pcs
- Set of 3 Polishing Compound - 3 pcs

Weight (gross): 140 g (4.9 oz)

Pcs per carton: 50

LS8P1 – Compact One-Sided Leather Paddle Strop with Polishing Compound



Total length, mm/"	350/13.8
Length of the working part, mm/"	220/8.6
Working width, mm/"	25/1
Base material	Ash wood

Items included

- Strop 1 pcs
- Polishing Compound - 1 pcs

Weight (gross): 150 g (5.3 oz)

Pcs per carton: 50

LS9P2 – Pocket Double-Sided Leather Paddle Strop 2 Polishing Compounds



Length of leather part, mm/"	200/8
Width, mm/"	35/1.4
Thickness, mm/"	16/0.6
Material	Ash wood

Items included

- Strop 1 pcs
- Green Polishing Compound - 1 pcs
- White Polishing Compound - 1 pcs

Weight (gross): 120 g (4.2 oz)

Pcs per carton: 50

LHS1 – Double-Sided Leather Hanging Strop



Length, mm/"	650/25.6
Width, mm/"	45/1.8
Thickness, mm/"	4/0.16
Material	Cowhide leather, metal hardware
Loop length, mm/"	110/4.3
Carabiner inner diameter, mm/"	20/0.8

Items included

- Strop 1 pcs
- Polishing Compound - 1 pcs

Weight (gross): 110 g (3.9 oz)

Pcs per carton: 6

PW1/PW2 – Polishing Wheel with Compound

• Leather

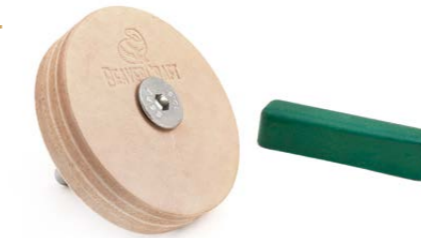

• Felt

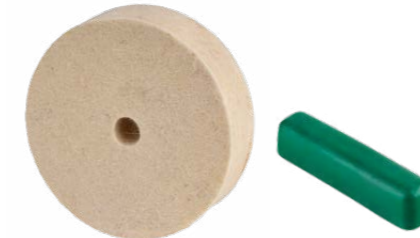

Diameter, mm/"	76/3
Width, mm/"	19/0.8
Tang diameter, mm/"	7/0.3
Tang length, mm/"	30/1.2
Material	Natural leather/Natural felt

Items included

- Leather circle + screw + nut + washer
- Felt Polishing Compound - 1 pcs

Weight (gross): 175 g (6.2 oz)

Pcs per carton: 64

P01/P02 – Polishing Compound

• P01



• P02



Composition

- Aluminium oxide (80%)
- Split fat (18%)
- Kerosene (2%)

Non-hazardous

• P01 Weight (gross): 25 g (0.9 oz)

Pcs per carton: 100

• P02 Weight (gross): 56 g (2 oz)

Pcs per carton: 50

P03 – Set of 3 Polishing Compounds – Red, White, Green



Grain size (white)	28 μm (600 grit – 1st step)
Grain size (red)	14 μm (1500 grit – 2nd step)
Grain size (green)	7 μm (3000 grit – 3rd step)
Quantity, pcs	3

Weight (gross): 90 g (3.2 oz)

Pcs per carton: 90

Accessories

Practical workshop and wood carving accessories, including cut-resistant tape and gloves, aprons, tool rolls, belt holders, finishing waxes, and other useful essentials for carvers and craftsmen.



W35/W60 – Natural Beeswax for Wood Finishing

• 35 ml



Ingredients	Beeswax. natural oil (linseed)
Color	Yellow
Volume, ml	35
Weight (gross), g/(oz)	40/1.4
Pcs per carton	6

• 60 ml



Ingredients	Beeswax. natural oil (linseed)
Color	Yellow
Volume, ml	60
Weight (gross), g/(oz)	65/2.3
Pcs per carton	6

NCT6 – Cut-Resistant Finger Tape, 6 pcs

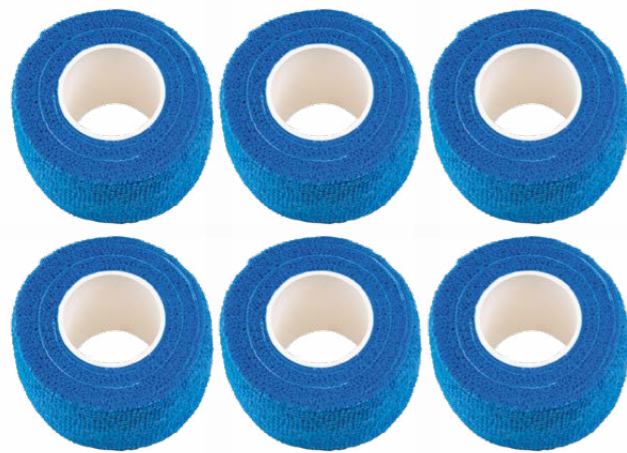

Length, cm/"	450/177
Width, cm/"	5/2
Material	Textile, non-woven tape with reinforcing fibers
Color	Blue
Weight (gross), g/(oz)	140/4.9
Pcs per carton	48

CRG – Cut-Resistant Wood Carving Gloves, sizes S/M/L



Material	Polyester, Polyethylene, Spandex
Color	Gray milange
Weight (gross), g/(oz)	60/2.1
Pcs per carton	50

TH10_Dark – 10-Compartment Wooden Tool Holder – Dark Finish



Width, mm/"	250/9.8
Height, mm/"	220/8.6
Depth, mm/"	105/4.1
Rack height, mm/"	95/3.7
Holes diameter, mm/"	35/1.4
Material	Plywood
Color	Brown
Weight (gross), g/(oz)	330/11.6
Pcs per carton	6

TH20_Dark – 20-Compartment Wooden Tool Holder – Dark Finish



Width, mm/"	500/19.6
Height, mm/"	265/10.4
Depth, mm/"	110/4.3
Rack height, mm/"	95/3.7
Shelf height, mm/"	55/2.1
Holes diameter, mm/"	35/1.4
Material	Plywood
Color	Brown
Weight (gross), g/(oz)	970/34.2
Pcs per carton	6

SH1 – Leather Knife Sheath for Whittling



Length, mm/"	150/6
Width, mm/"	65/2.6
Diameter, mm/"	30/1.2
Depth, mm/"	90/3.5
Material	Cowhide leather
Color	Brown
Weight (gross), g/(oz)	50/1.8
Pcs per carton	6

SH2 – Leather Knife Sheath for Spoon Carving Hook Knife



Length, mm/"	79/3.1
Width, mm/"	65/2.5
Material	Leather
Color	Brown
Weight (gross), g/(oz)	12/0.4
Pcs per carton	6

SH5 – Leather Knife Sheath for Spoon Carving Hook Knife



Length, mm/"	85/3.3
Width, mm/"	60/2.3
Material	Leather
Color	Brown
Weight (gross), g/(oz)	15/0.5
Pcs per carton	6

TR4 – 4-Slot Canvas Tool Storage Roll



Height, mm/"	335/13
Width, mm/"	280/11
Pockets quantity	4
Pockets width, mm/"	65/2.5
Pockets depth, mm/"	100/3.9
Material	Canvas
Color	Green
Weight (gross), g/(oz)	110/3.9
Pcs per carton	6

TR6 – 6-Slot Canvas Tool Storage Roll



Height, mm/"	350/13.7
Width, mm/"	420/16.5
Pockets quantity	6
Pockets width, mm/"	65/2.5
Pockets depth, mm/"	95/3.7
Material	Canvas
Color	Green
Weight (gross), g/(oz)	150/5.3
Pcs per carton	6

TR12 – 12-Slot Canvas Tool Storage Roll



Height, mm/"	490/19.3
Width, mm/"	405/15.9
Pockets quantity	12
Pockets width, mm/"	65/2.5
Pockets depth, mm/"	80/3.1
Material	Canvas
Color	Green
Weight (gross), g/(oz)	200/7.1
Pcs per carton	6

TR3X14 – 4-Slot Leather Tool Storage Case



Height when opened, mm/"	220/8.6
Width when opened, mm/"	300/11.8
Pockets quantity	4
Pockets width, mm/"	1st-3d: 35/1.4/ 4th: 25/0.9
Pockets depth, mm/"	70/2.7
Material	Leather
Color	Brown/Black
Weight (gross), g/(oz)	160/5.6
Pcs per carton	6

TR8X – 8-Slot Leather Tool Storage Roll



Height when opened, mm/"	250/9.8
Width when opened, mm/"	530/20.9
Pockets quantity	8+2
Thickness of the leather, mm/"	1.6/0.1
Pockets width, mm/"	1st: 55/2.1/2nd-8th: 50/1.9/ 9th: 40/1.5/10th: 25/0.9
Pockets depth, mm/"	70/2.7
Material	Leather
Color	Brown
Weight (gross), g/(oz)	450/15.9
Pcs per carton	6

TR9X – 9-Slot Leather Tool Storage Bag



Height when opened, mm/"	270/10.6
Width when opened, mm/"	750/29.5
Pockets quantity	8+1
Thickness of the leather, mm/"	1.6/0.1
Pockets width, mm/"	30/1.2
Pockets depth, mm/"	50/1.9
Material	Leather
Color	Brown/Black/Grey
Weight (gross), g/(oz)	1650/58.2
Pcs per carton	6

TR21 – 4-Slot Leather Tool Storage Case



Height, mm/"	325/12.8
Width, mm/"	215/8.4
Pockets quantity	4
Pockets width, mm/"	40/1.5
Pockets depth, mm/"	100/3.9
Material	Leather
Color	Brown
Weight (gross), g/(oz)	400/14.1
Pcs per carton	6

AP1 – Adjustable Green Canvas Work Apron



Length, mm/"	863/34
Width, mm/"	686/27
Material	Canvas
Color	Green
Weight (gross), g/(oz)	500/17.6
Pcs per carton	6

AP2X – Adjustable Brown Leather Work Apron



Length, mm/"	770/30.3
Width, mm/"	600/23.6
Material	Leather
Color	Dark brown
Weight (gross), g/(oz)	700/24.7
Pcs per carton	6

AP3X – Adjustable Black and Brown Leather Work Apron



Length, mm/"	762/30
Width, mm/"	600/23.6
Material	Leather
Color	Black & Brown
Weight (gross), g/(oz)	700/24.7
Pcs per carton	6

AP4 – Adjustable Canvas and Leather Work Apron



Length, mm/"	838/33
Width, mm/"	640/25.2
Material	Leather, canvas
Color	Brown & Blue
Weight (gross), g/(oz)	600/21.2
Pcs per carton	6

AP5 – Adjustable Leather Carving Bib



Length, mm/"	240/9.4
Width, mm/"	220/8.6
Material	Leather
Color	Brown
Weight (gross), g/(oz)	270/9.5
Pcs per carton	6

AP_Mini – Adjustable Mini Leather Carving Bib



Length, mm/"	100/4
Width, mm/"	120/4.7
Material	Leather
Color	Brown
Weight (gross), g/(oz)	55/2
Pcs per carton	6

LC_AP_01 – Leather Wood Carving Apron



Length, mm/"	590/23.2
Width, mm/"	540/21.2
Thickness of the leather, mm/"	2/0.1
Material	Leather, metal hardware
Color	Dark brown
Weight (gross), g/(oz)	380/13.4
Pcs per carton	6

LC_BO_01 – Leather Tool Belt Pouch



Length, mm/"	350/13.8
Width, mm/"	230/9.1
Thickness, mm/"	40/1.6
Thickness of the leather, mm/"	2/0.1
Material	Leather, metal hardware
Color	Dark brown & Light brown
Weight (gross), g/(oz)	300/10.6
Pcs per carton	6

LC_Set_01 – Leather Work Apron and Tool Belt Pouch Set



Apron	
Length, mm/"	590/23.2
Width, mm/"	540/21.2
Thickness of the leather, mm/"	2/0.1
Material	Leather, metal hardware
Color	Dark brown
Belt Pouch	
Length, mm/"	350/13.8
Width, mm/"	230/9.1
Thickness, mm/"	40/1.6
Thickness of the leather, mm/"	2/0.1
Material	Leather, metal hardware
Color	Dark brown & Light brown

Weight (gross): 680 g (24 oz)
Pcs per carton: 6

LC_TH_17 – 17-Slot Leather Tool Storage Roll Bag



Length, mm/"	310/12.2
Width, mm/"	615/24.2
Thickness of the leather, mm/"	2/1
Material	Leather, metal hardware
Color	Dark brown & Light brown
Weight (gross), g/(oz)	620/21.9
Pcs per carton	6

LC_WH_01 – Leather Tool Wall Hanger



Length, mm/"	80/3.1
Width, mm/"	130/5.1
Thickness of the leather, mm/"	3/0.1
Material	Leather, metal hardware
Color	Light brown
Weight (gross), g/(oz)	40/1.4
Pcs per carton	6

LC_Keychain_01 – Leather Keychain



Length, mm/"	50/2
Width, mm/"	30/1.2
Material	Leather, metal hardware
Color	Dark brown & Light brown
Weight (gross), g/(oz)	5/0.2
Pcs per carton	6

LC_WH_02 – Leather Dual-Tool Wall Hanger



Length, mm/"	180/7.1
Width, mm/"	130/5.1
Thickness of the leather, mm/"	3/0.1
Material	Leather, metal hardware
Color	Light brown
Weight (gross), g/(oz)	50/1.8
Pcs per carton	6

LC_BH_01 – Leather Tool Belt Hanger



Length, mm/"	130/5.1
Width, mm/"	80/3.1
Thickness of the leather, mm/"	3/0.1
Material	Leather, metal hardware
Color	Light brown
Weight (gross), g/(oz)	30/1.1
Pcs per carton	6

LC_CB_01 – Leather and Canvas Foraging Belt Bag



Folded	
Length, mm/"	125/5
Width, mm/"	100/4
Thickness, mm/"	40/1.5
Unfolded	
Length, mm/"	270/10.5
Width, mm/"	215/8.5
Thickness, mm/"	5/0.2
Material	Leather, canvas, metal hardware
Color	Brown & Green
Weight (gross), g/(oz)	130/4.6
Pcs per carton	6

LC_PP_01 – Leather Pocket Protector



Length, mm/"	170/6.7
Width, mm/"	120/4.7
Thickness, mm/"	8/0.3
Pocket Depth, mm/"	130/5.1
Material	Leather
Color	Light brown
Weight (gross), g/(oz)	60/2.1
Pcs per carton	6

LC_KB – Leather Yoga Mat Holder Carrier Strap



Strap Length, mm/"	665/26.2
Handle Length, mm/"	350/13.8
Thickness of the leather, mm/"	2/1
Material	Leather, metal hardware
Color	Chocolate brown
Weight (gross), g/(oz)	100/3.5
Pcs per carton	6

LC_B1 – Double-Prong Leather Utility Belt



Length, mm/"	120/4.7
Width, mm/"	50/2
Thickness, mm/"	4/0.15
Material	Leather, metal hardware
Color	Light brown & Black
Weight (gross), g/(oz)	320/11.3
Pcs per carton	6

LC_BH6 – 17-Slot Leather Tool Storage Roll Bag



Height, mm/"	305/12
Width, mm/"	265/10.4
Thickness, mm/"	165/6.5
Material	Leather, metal hardware
Handle material	Ash wood
Color	Light brown & Brown
Weight (gross), g/(oz)	600/21.2
Pcs per carton	6

LC_B2 – Double-Prong Leather Utility Belt



Length, mm/"	120/4.7
Width, mm/"	40/1.6
Thickness, mm/"	4/0.15
Material	Leather, metal hardware
Color	Light brown & Black
Weight (gross), g/(oz)	400/14.1
Pcs per carton	6

PARTNER WITH US

We work globally
with partners around the world



Manufacturing: **UKRAINE**
Warehouses: **USA, GERMANY**

Contact Us



Become a Dealer

wholesale@beavercraft.team
beavercrafttools.com

BEAVERCRAFT

MADE IN UKRAINE
BEAVERCRAFTTOOLS.COM